

1 2 3 4 5 6 7 8

A

B

C

D

E

F

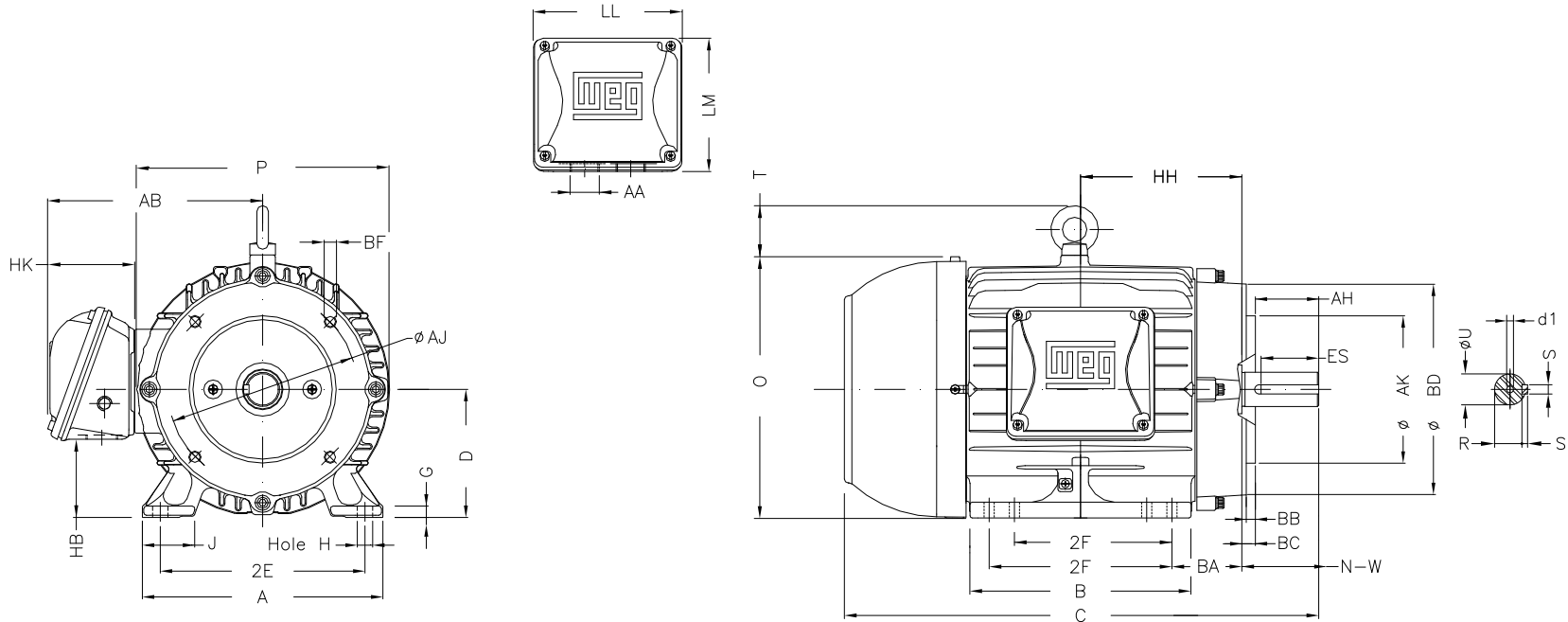

Notes: Downloaded from <http://dealerselectric.com>
Generated for Model #01018ET3H215TC-W22

2E	J	A	P	AB
8.500	1.772	9.764	10.669	8.583
2F	K	B	BA	FBA
5.500/7.000	2.165	8.858	3.500	5.921
U	N-W	ES	S	R
1.375	3.375	2.480	0.313	1.203
depth	D	G	HB	O
0.313	5.250	0.669	2.985	10.841
T	HF	HH	HK	EV
1.772	5.250	7.000	3.150	0.929
H	C	FC	LL	LM
0.410	19.517	22.546	5.512	5.236
AA	d1	Flange	AJ	AK
NPT 1"	A 4	FC-184	7.250	8.500
BD	BF	BB	BC	AH
8.875	UNC 1/2"x13	0.250	0.250	3.125

Performed by:

Checked:

Customer:

W22 NEMA Premium - Ball Bearings

Three-phase induction motor
Frame 213/5T - IP55

13-SEP-2016

