

1 2 3 4 5 6 7 8

A

B

C

D

E

F

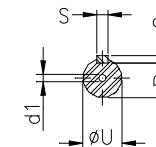
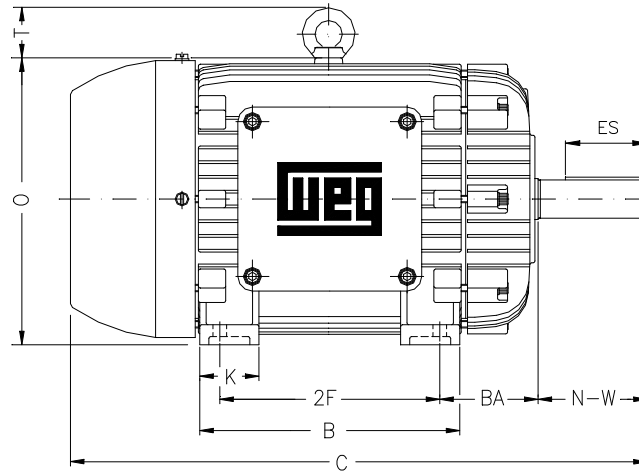
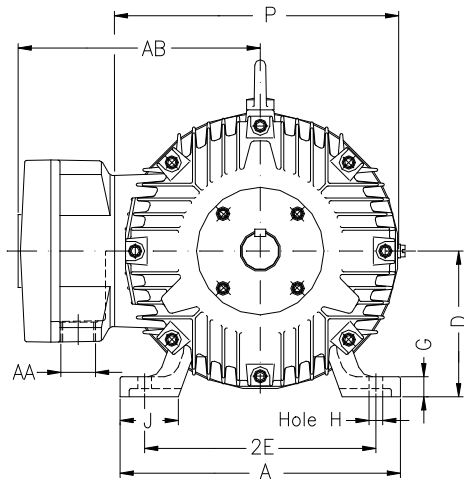

Notes: Downloaded from <http://dealerselectric.com>
Generated for Model #01009XP3E284T

Performed by:

Checked:

Customer:

Three-Phase : Explosion Proof - High Efficiency

Three-phase induction motor
Frame 284T - IP54

13-SEP-2016



2E 11.000	A 13.780	2F 9.500	B 11.575	BA 4.750
J 3.150	K 2.953	P 14.094	ES 3.149	depth 0.500
S 0.500	N-W 4.622	U 1.875	R 1.594	AB 11.850
D 7.000	G 1.024	O 14.362	H 0.531	C 26.407
AA NPT 1 1/2"	d1 A 4	d2 A 4	T 2.441	