

1 2 3 4 5 6 7 8

A

B

C

D

E

F

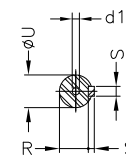
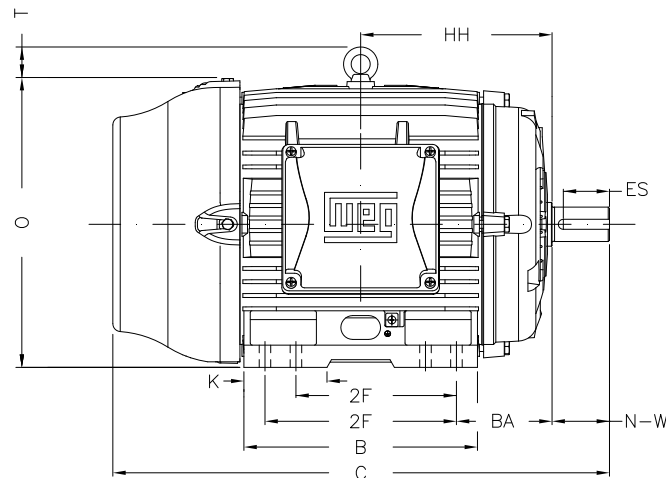
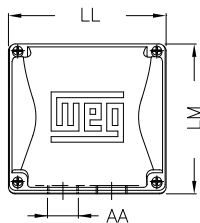
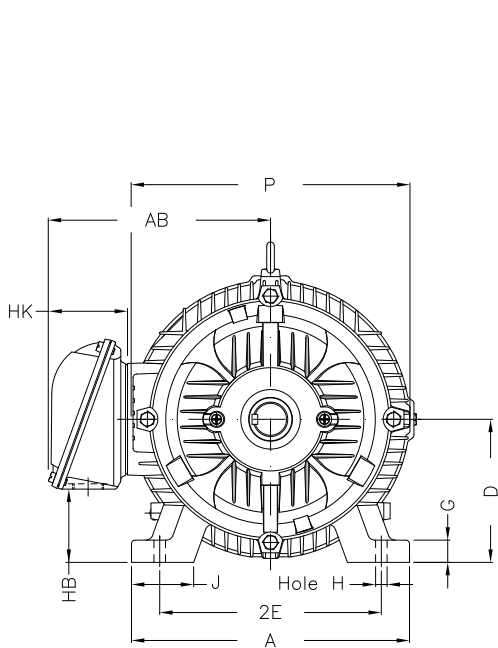

Notes: Downloaded from <http://dealerselectric.com>
Generated for Model #01009ST3HIE284T-W22

Performed by:

Checked:

Customer:

Three-Phase: W22 IEEE-841™ Petrochem Motors - NEMA Premium® Efficiency

Three-phase induction motor
Frame 284/6T - IP55

13-SEP-2016



2E 11.000	J 3.071	A 13.780	P 14.173	AB 11.073
2F 9.500/11.000	K 3.583	B 13.071	BA 4.750	U 1.875
N-W 4.622	ES 3.149	S 0.500	R 1.594	depth 0.500
D 7.000	G 1.023	HB 3.535	O 14.067	T 2.087
HF 7.000	HH 10.250	HK 3.976	H 0.531	C 27.929
LL 7.815	LM 7.480	AA NPT 1 1/2"	d1 A 4	d2 A 4