

1 2 3 4 5 6 7 8

A

B

C

D

E

F

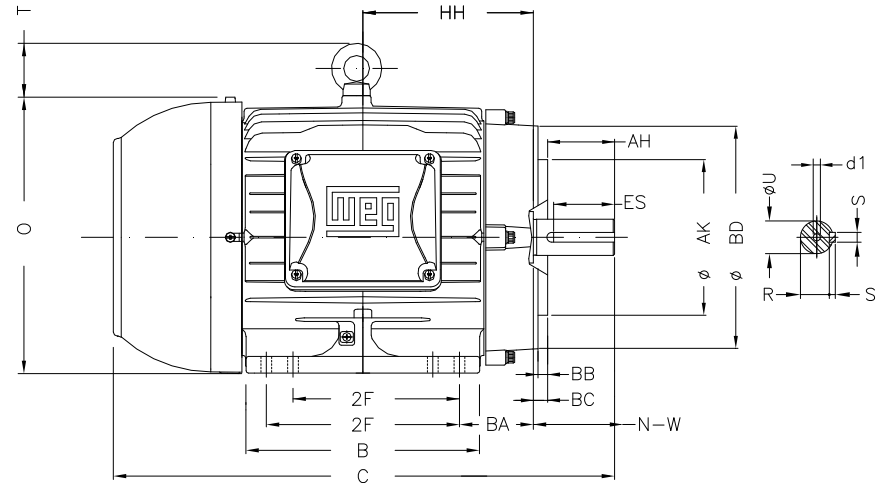
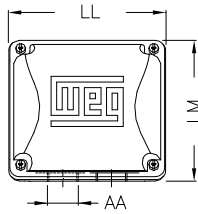
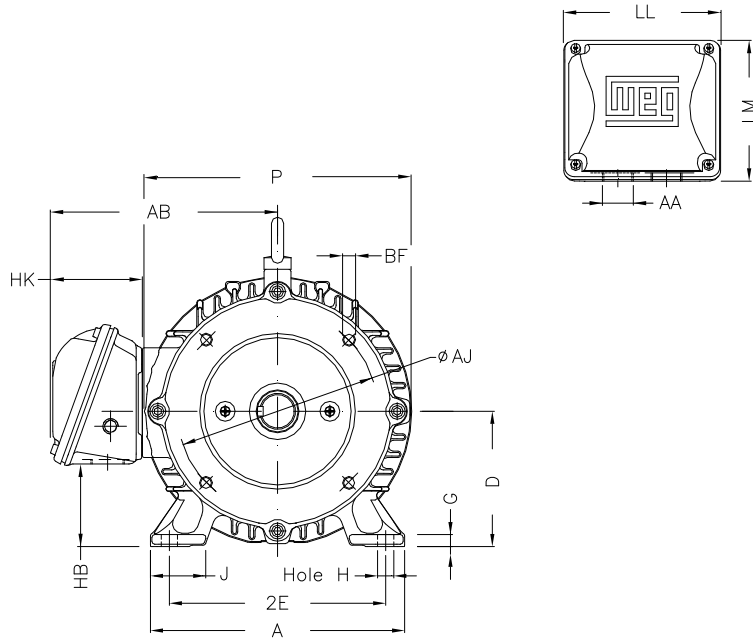

Notes: Downloaded from <http://dealerselectric.com>
Generated for Model #00736ST3QIE213TC-W22

Performed by:

Checked:

Customer:

Three-Phase: W22 IEEE-841™ Petrochem Motors - NEMA Premium® Efficiency

Three-phase induction motor
Frame 213/5T - IP55

13-SEP-2016



2E	J	A	P	AB
8.500	1.772	9.764	10.669	8.583
2F	K	B	BA	U
5.500/7.000	2.165	8.858	3.500	1.375
N-W	ES	S	R	depth
3.375	2.756	0.313	1.203	0.313
D	G	HB	O	T
5.250	0.649	2.985	10.841	1.772
HF	HH	HK	H	C
5.250	7.000	3.150	0.406	19.517
LL	LM	AA	d1	d2
5.512	5.236	NPT 1"	A 4	A 4
Flange	AJ	AK	BD	BF
FC-184	7.250	8.500	8.875	UNC 1/2"x13
BB	BC	AH		
0.250	0.250	3.125		