

1 2 3 4 5 6 7 8

A

B

C

D

E

F

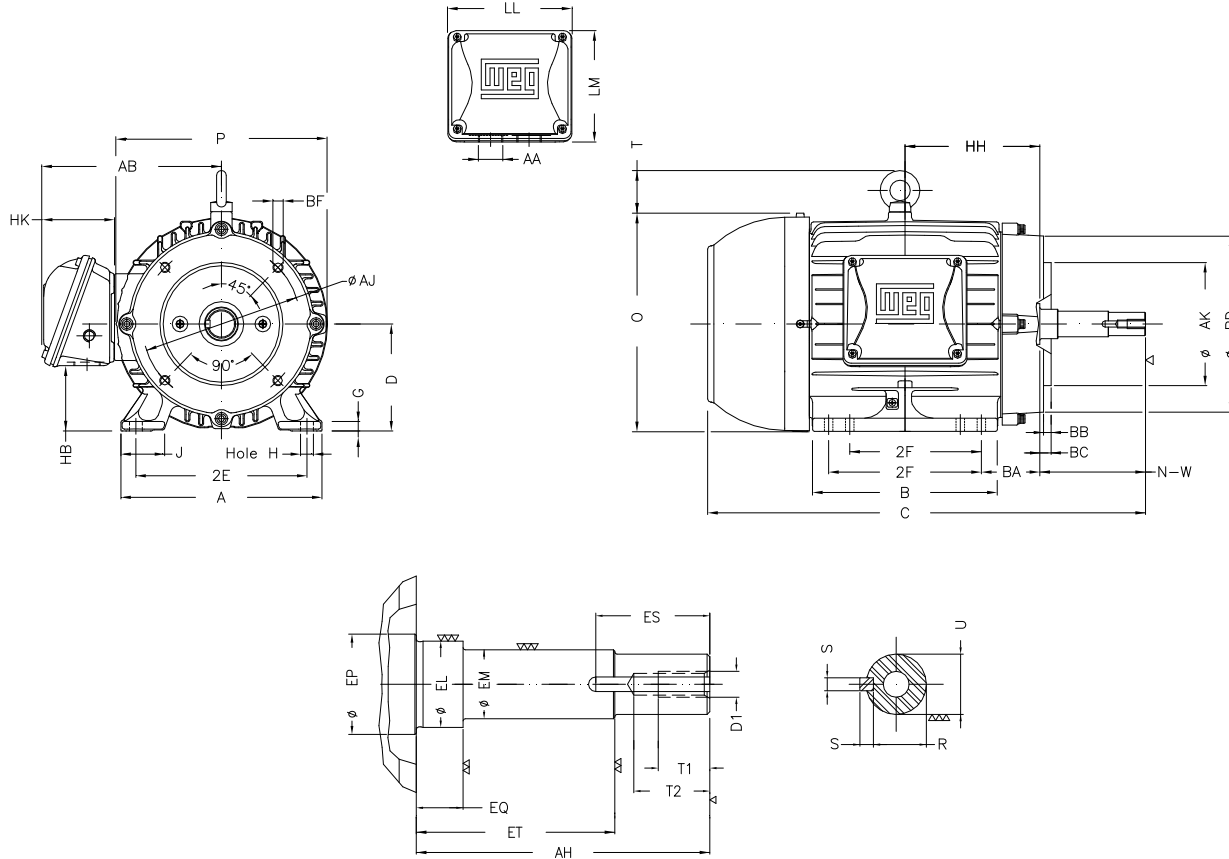

Notes: Downloaded from <http://dealerselectric.com>  
Generated for Model #00736ET3E213JP-W22

Performed by:

Checked:

Customer:

Close Coupled Pump: Three-Phase - W22 "JP" Type - TEFC - NEMA Premium

Three-phase induction motor  
Frame 213/5JP - IP55

13-SEP-2016



2E 8.500	J 1.772	A 9.764	P 10.669	AB 8.583
2F 5.500/7.000	K 2.165	B 8.858	BA 3.500	D 5.250
G 0.669	O 10.841	T 1.772	H 0.406	AA NPT 1"
EQ 2.382	ET 5.886	U 1.249	EM 1.375	EL 1.750
EP 1.770	ES 2.480	t1 0.984	t2 1.496	C 24.264
d1 EUNC 1/2"-13	HH 7.000	HK 3.150	HB 2.985	LL 5.512
LM 5.236	S 0.250	R 1.110	Flange FC-184	AJ 7.252
AK 8.500	BD 8.858	BF UNC 1/2"x13	BB 0.248	AH 8.130