

1 2 3 4 5 6 7 8

A

B

C

D

E

F

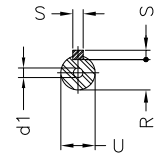
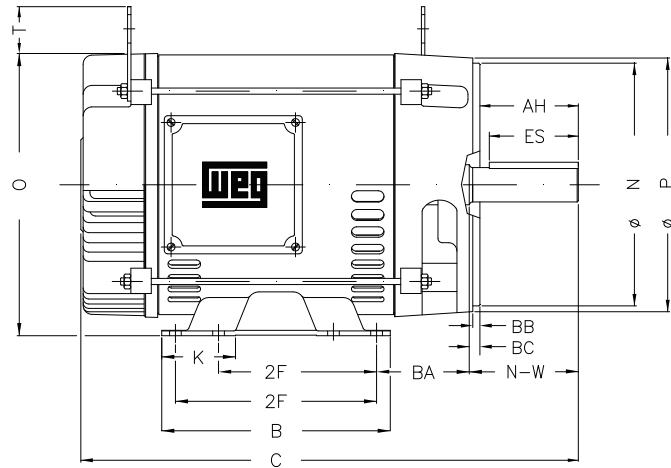
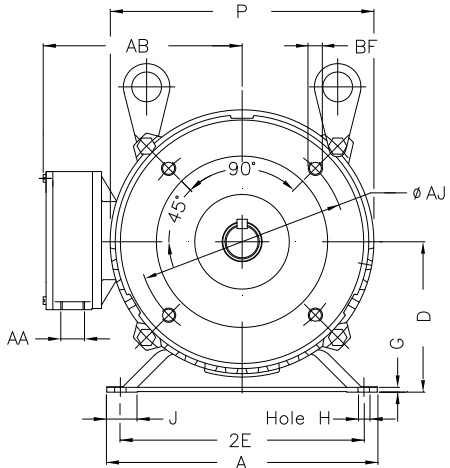

Notes: Downloaded from <http://dealerselectric.com>  
Generated for Model #007180T3E213TC

Performed by:

Checked:

Customer:

ODP – Open Induction Motors – NEMA Premium Efficiency

Three-phase induction motor  
Frame 213/5T - IP21

13-SEP-2016



2E 8.500	J 1.063	A 9.448	P 8.779	AB 8.149
2F 5.500/7.000	K 2.567	B 7.952	BA 3.488	U 1.375
d1 A 4	N-W 3.375	ES 2.480	S 0.313	R 1.203
depth 0.313	D 5.250	G 0.187	O 9.842	T 1.378
H 0.406	C 17.165	AA NPT 1"	Flange FC-184	AJ 7.250
AK 8.500	BD 8.875	BF UNC 1/2"x13	BB 0.250	BC 0.250