

1 2 3 4 5 6 7 8

A

B

C

D

E

F

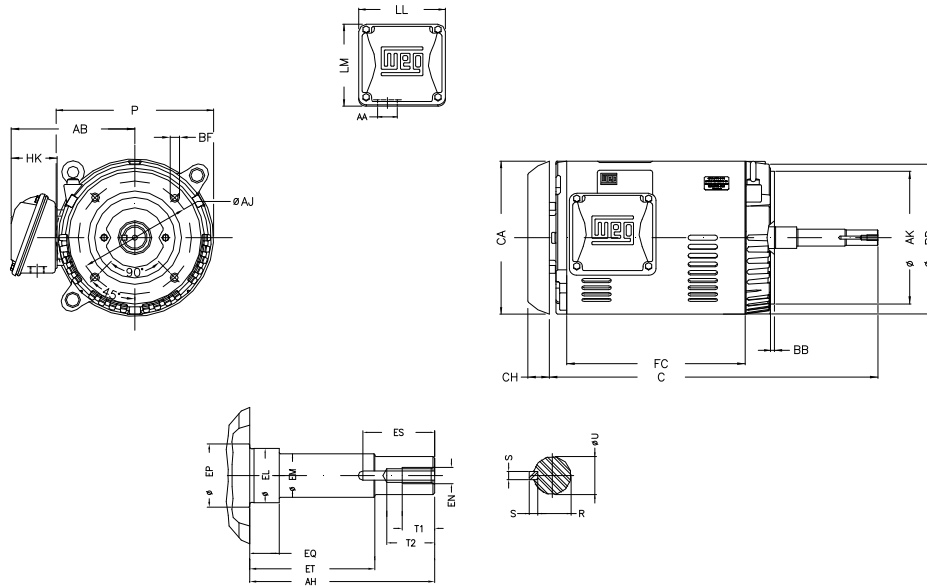

Notes: Downloaded from <http://dealerselectric.com>
Generated for Model #007180P3E213JMV-S

Performed by:

Checked:

Customer:

Close Coupled Pump: Three-Phase - W01 (Rolled Steel) "JM" Type - ODP - High

Three-phase induction motor
Frame 213/5JM - ODP

13-SEP-2016



P 9.846	AB 7.973	AA 1.377"	ER 4.258	EQ 0.630
ET 2.880	U 0.8745	EM 1.000	EL 1.250	EP 1.769
ES 1.575	t1 0.748	t2 1.102	C 17.717	FC 10.236
Flange FC-184	AJ 7.250	AK 8.500	BD 9.401	BF UNC 1/2"x13
BB 0.250	AH 4.258			