

1 2 3 4 5 6 7 8

A
B
C
D
E
F

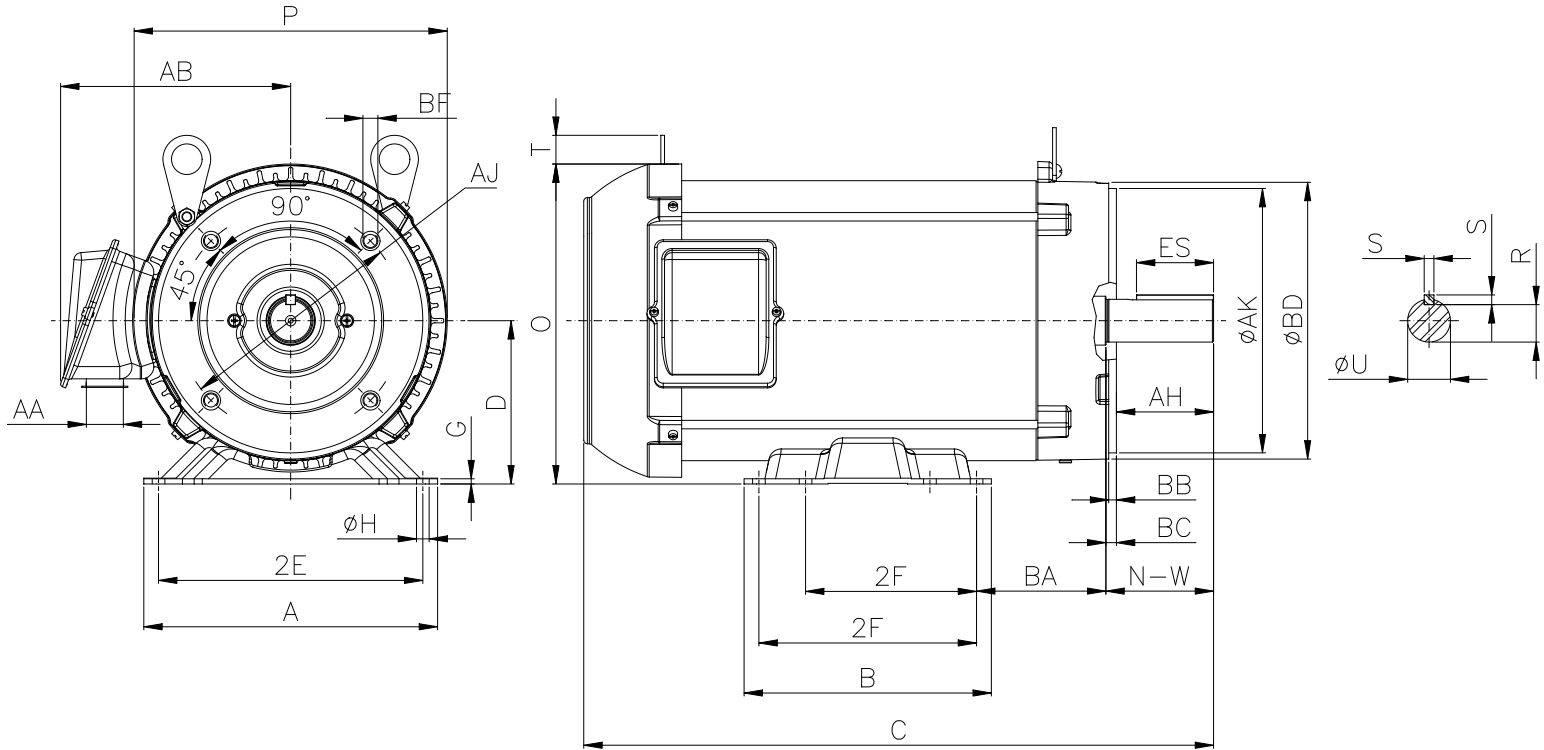

Notes: Downloaded from <http://dealerselectric.com>
Generated for Model #00718ET3ERS213TC

Performed by:

Checked:

Customer:

Three-Phase : Rolled Steel Motor - NEMA Premium Efficiency

2E 8.500	A 9.449	P 10.071	AB 7.398	2F 5.500/7.000
B 7.953	BA 4.250	U 1.375	N-W 3.375	ES 2.480
S 0.313	R 1.203	depth 0.313	D 5.250	G 0.167
O 10.285	T 0.923	H 0.406	C 20.257	d1 A 4
d2 A 4	Flange FC-184	AJ 7.250	AK 8.500	BD 8.875
BF UNC 1/2"x13	BB 0.250	BC 0.250	AH 3.125	

Three-phase induction motor
Frame 213T - IP55

13-SEP-2016

