

1 2 3 4 5 6 7 8

A
B
C
D
E
F

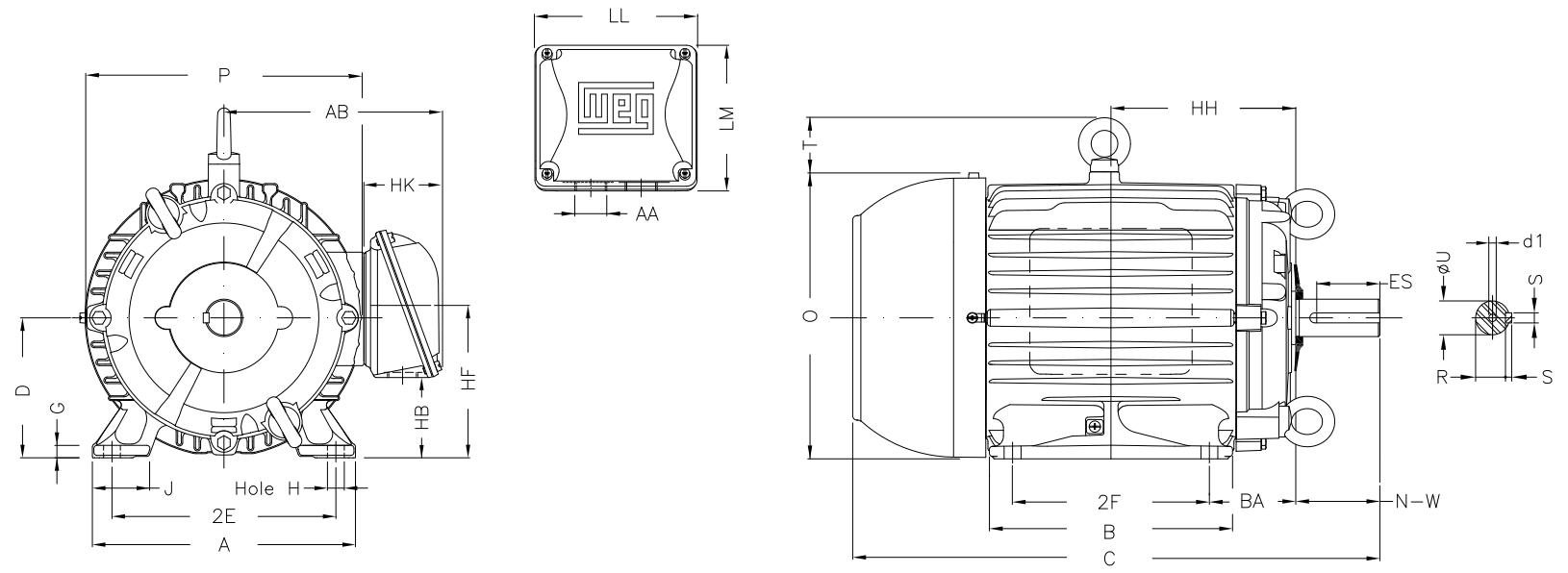

Notes: Downloaded from <http://dealerselectric.com>
Generated for Model #00718ET3ECT213T-W22

Performed by:

Checked:

Customer:

W22 Cooling Tower Motors: NEMA Premium - TEFC

Three-phase induction motor
Frame 213T - IP55

13-SEP-2016



2E 8.500	J 1.772	A 9.764	P 10.669	AB 8.667
2F 5.500	K 2.165	B 7.362	BA 3.500	U 1.375
N-W 3.375	ES 2.480	S 0.313	R 1.203	depth 0.313
D 5.250	G 0.669	HB 2.985	O 10.841	T 1.772
HF 5.250	HH 6.250	HK 3.150	H 0.406	C 18.021
LL 5.512	LM 5.236	AA NPT 1"	d1 A 4	d2 A 4