

1 2 3 4 5 6 7 8

A

B

C

D

E

F

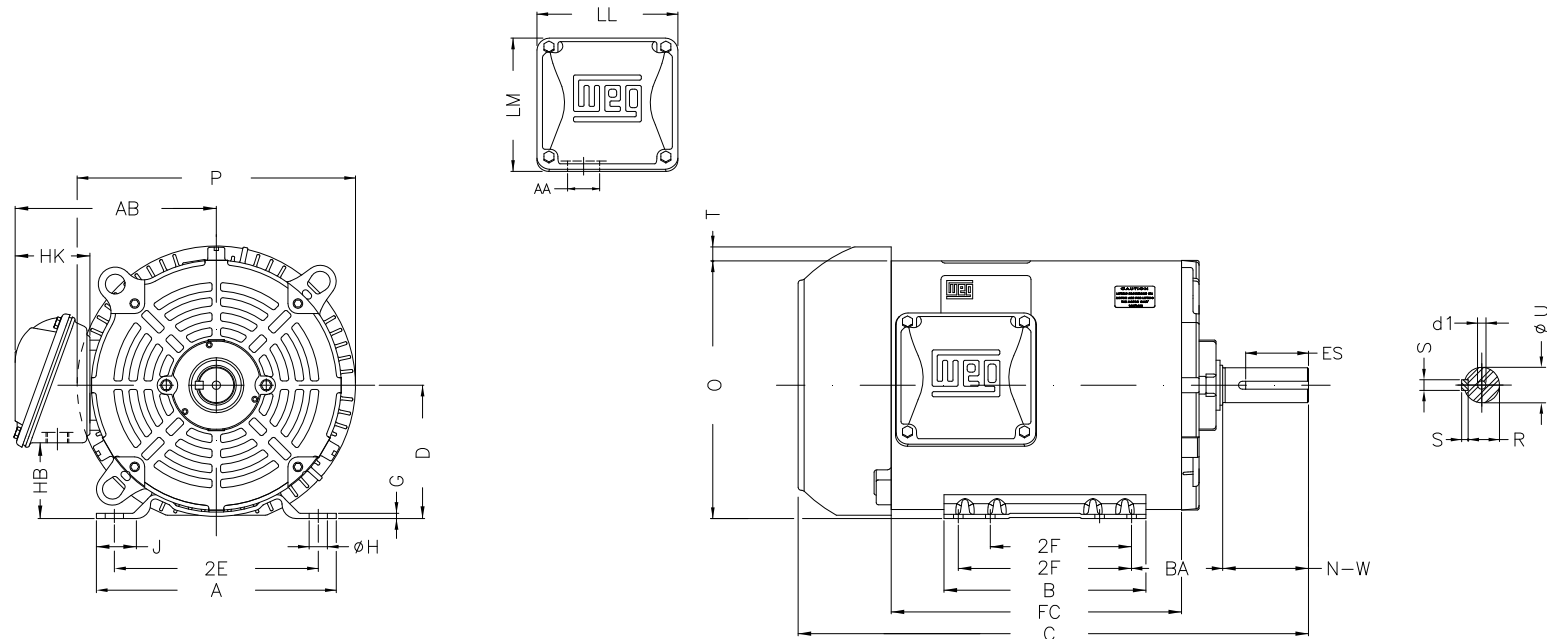

Notes: Downloaded from <http://dealerselectric.com>  
Generated for Model #00718ET3E213T-S

Performed by:

Checked:

Customer:

Three Phase: W01 (Rolled Steel) - TEFC - NEMA Premium Efficiency

Three-phase induction motor  
Frame 213/5T - IP55

13-SEP-2016



P	AB	J	2E	A
10.965	7.973	1.575	8.500	9.449
H	G	HB	HK	T
0.406	0.167	2.982	3.022	0.761
O	FC	2F	B	C
10.144	10.236	5.500/7.000	7.953	18.898
BA	N-W	ES	d1	S
3.500	3.380	2.480	A4	0.313
U	AA	depth	R	LL
1.375	1.377"	0.313	1.203	5.551
LM	BB	D	CH	
5.250	0.761	5.250	1.929	