

1 2 3 4 5 6 7 8

A

B

C

D

E

F

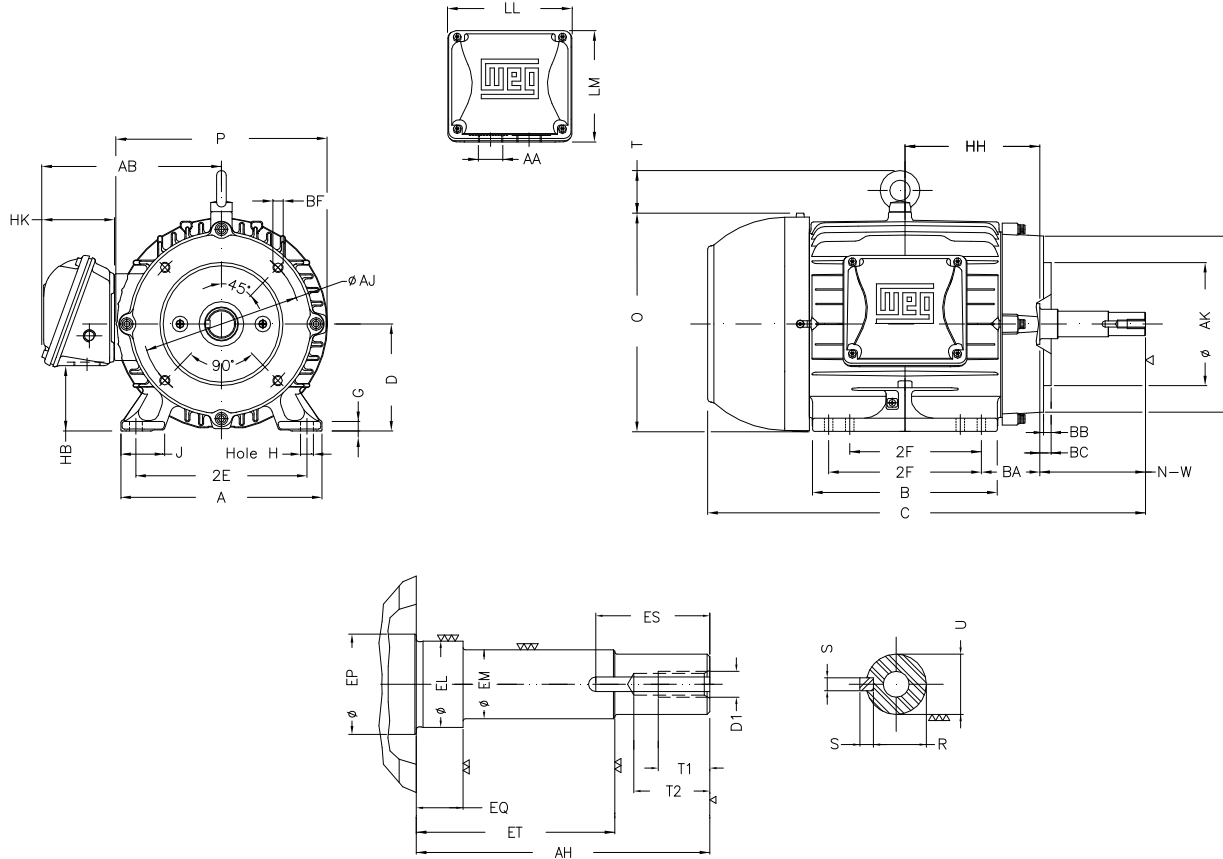

Notes: Downloaded from <http://dealerselectric.com>
Generated for Model #00718EP3H213JM-W22

Performed by:

Checked:

Customer:

Close Coupled Pump: Three-Phase - W22 "JM" Type - TEFC - High Efficiency

Three-phase induction motor
Frame 213/5JM - IP55

13-SEP-2016



2E	J	A	P	AB
8.500	1.772	9.764	10.669	8.583
2F	K	B	BA	D
5.500/7.000	2.165	8.858	3.500	5.250
G	O	T	H	AA
0.669	10.841	1.772	0.406	NPT 1"
EQ	ET	U	EM	EL
0.630	2.880	0.874	1.000	1.250
EP	ES	t1	t2	C
1.770	1.575	0.748	1.102	20.392
d1	HH	HK	HB	LL
EUNC 3/8"-16	7.000	3.150	2.985	5.512
LM	S	R	Flange	AJ
5.236	0.187	0.768	FC-184	7.252
AK	BD	BF	BB	AH
8.500	8.858	UNC 1/2"x13	0.248	4.258