

1 2 3 4 5 6 7 8

A
B
C
D
E
F

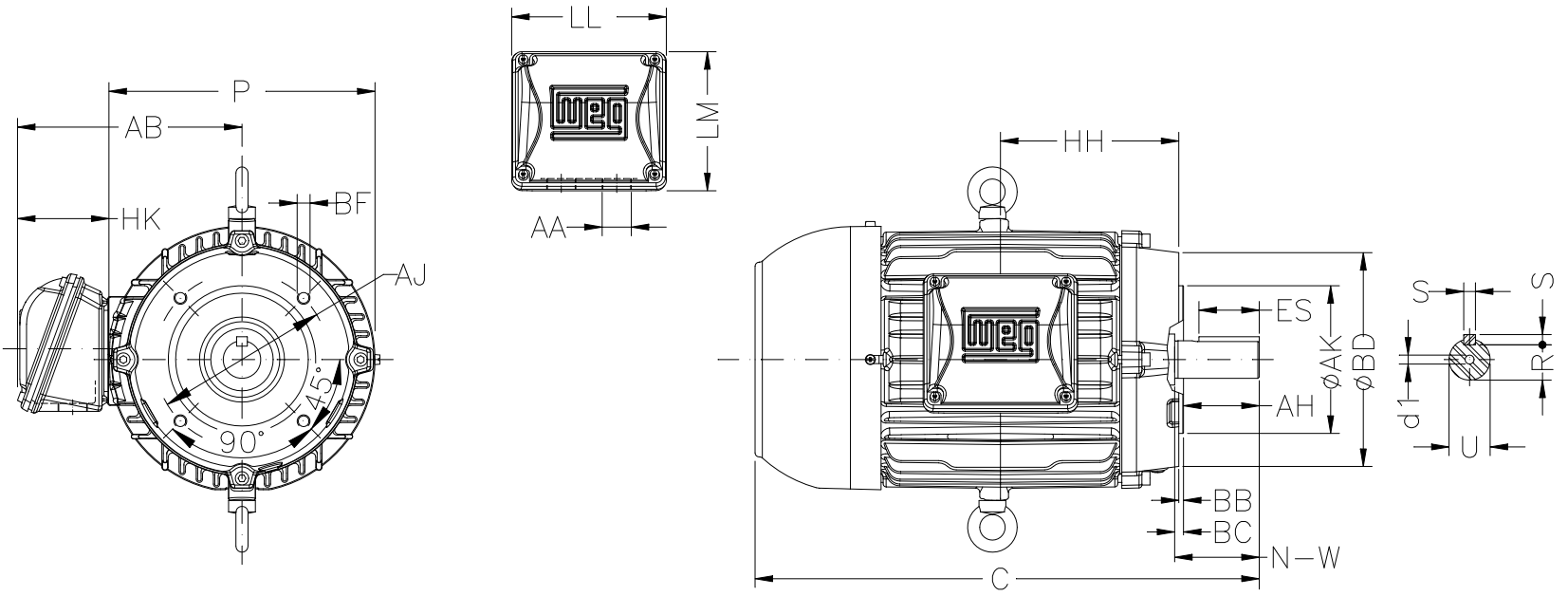

Notes: Downloaded from <http://dealerselectric.com>
Generated for Model #00718EP3ER213TC-W22

Performed by:

Checked:

Customer:

W22 High Efficiency

P	AB	U	N-W	ES
10.669	8.583	1.375	3.375	2.480
S	R	depth	HH	HK
0.313	1.203	0.313	6.250	3.150
C	LL	LM	AA	d1
18.021	5.512	5.236	NPT 1"	A 4
Flange	AJ	AK	BD	BF
FC-184	7.250	8.500	8.875	UNC 1/2"x13
BB	BC	AH		
0.250	0.250	3.125		

Three-phase induction motor
Frame 213T - IP55

13-SEP-2016

