

1 2 3 4 5 6 7 8

A

B

C

D

E

F

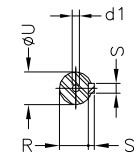
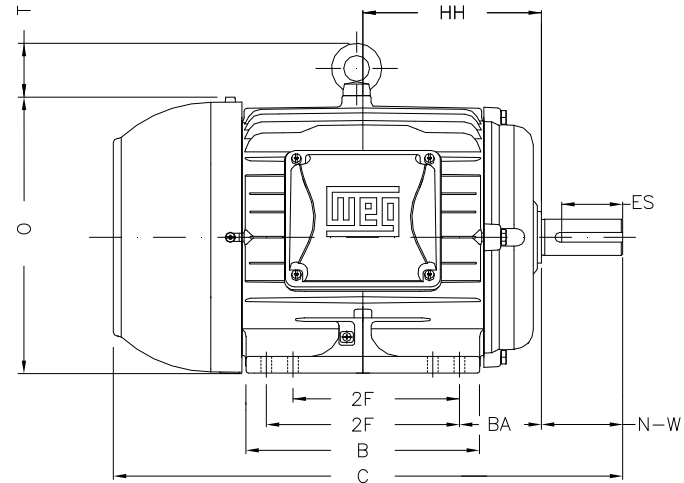
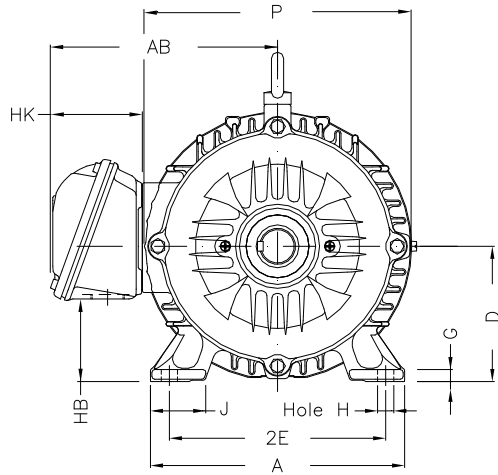
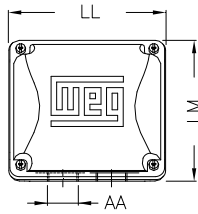

Notes: Downloaded from <http://dealerselectric.com>
Generated for Model #00718EG3E213T-W22

Performed by:

Checked:

Customer:

W22 Super Premium

Three-phase induction motor
Frame 213/5T - IP55

13-SEP-2016



2E 8.500	J 1.772	A 9.764	P 10.669	AB 8.583
2F 5.500/7.000	K 2.165	B 8.858	BA 3.500	FBA 5.921
U 1.375	N-W 3.375	ES 2.480	S 0.313	R 1.203
depth 0.313	D 5.250	G 0.669	HB 2.985	O 10.841
T 1.772	HF 5.250	HH 7.000	HK 3.150	H 0.410
C 19.517	LL 5.512	LM 5.236	AA NPT 1"	d1 A 4