

1 2 3 4 5 6 7 8

A

B

C

D

E

F

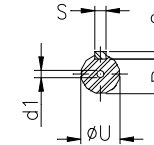
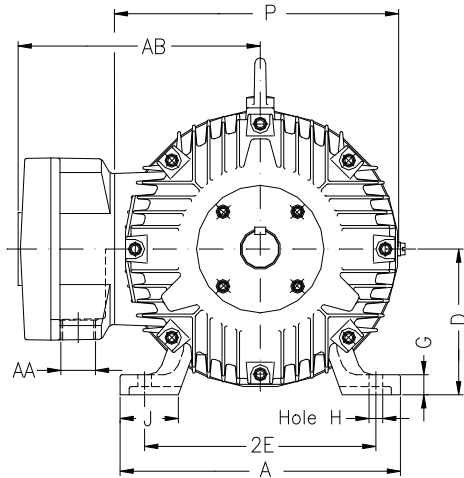

Notes: Downloaded from <http://dealerselectric.com>  
Generated for Model #00712XT3H254T

Performed by:

Checked:

Customer:

Three-Phase : Explosion Proof - NEMA Premium

Three-phase induction motor  
Frame 254T - IP55

13-SEP-2016



2E 10.000	A 12.126	2F 8.252	B 10.000	BA 4.250
J 2.520	K 2.559	P 12.224	ES 2.756	depth 0.375
S 0.375	N-W 4.000	U 1.625	R 1.416	AB 11.063
D 6.250	G 0.817	O 12.352	T 2.087	H 0.531
C 23.175	AA NPT 1 1/2"	d1 A 4	d2 A 4	