

1 2 3 4 5 6 7 8

A
B
C
D
E
F

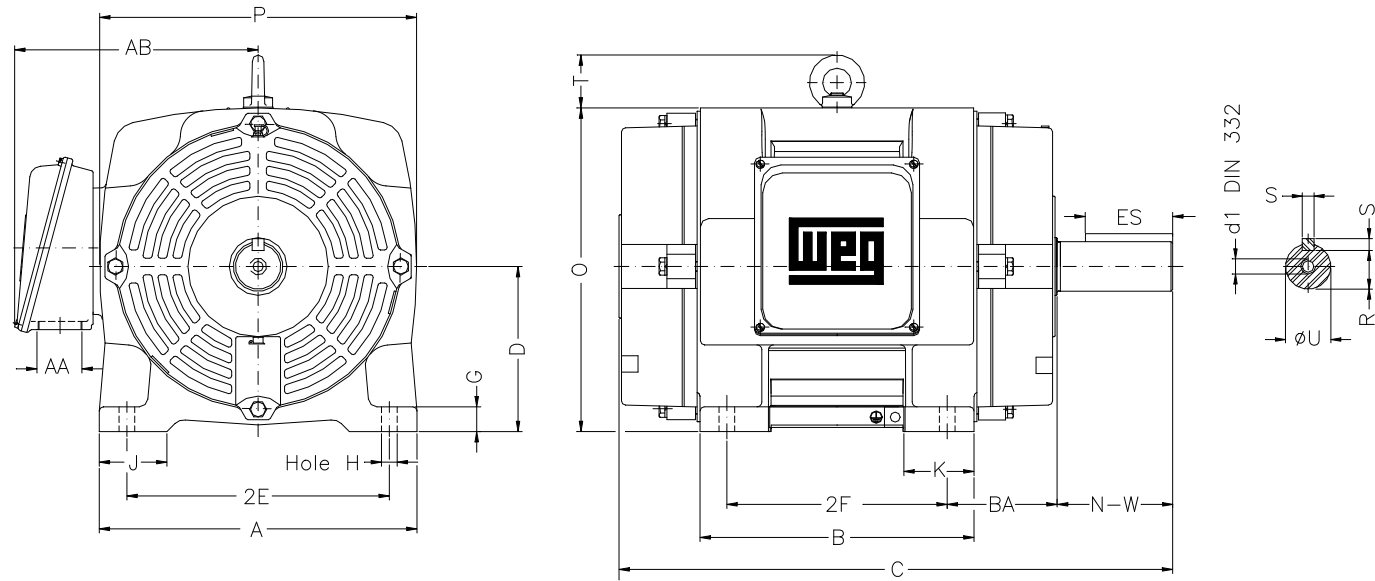

Notes: Downloaded from <http://dealerselectric.com>
Generated for Model #007120T3E254T

Performed by:

Checked:

Customer:

ODP – Open Induction Motors – NEMA Premium Efficiency

2E 10.000	J 2.520	A 12.130	P 11.812	AB 10.079
2F 8.250	K 2.560	B 10.100	BA 4.250	U 1.625
d1 A 4	N-W 4.000	ES 2.756	S 0.375	R 1.416
depth 0.375	D 6.250	G 0.787	O 12.204	T 2.165
H 0.531	C 20.669	AA NPT 1 1/2"		

Three-phase induction motor
Frame 254T - IP23

13-SEP-2016

