

1 2 3 4 5 6 7 8

A

B

C

D

E

F

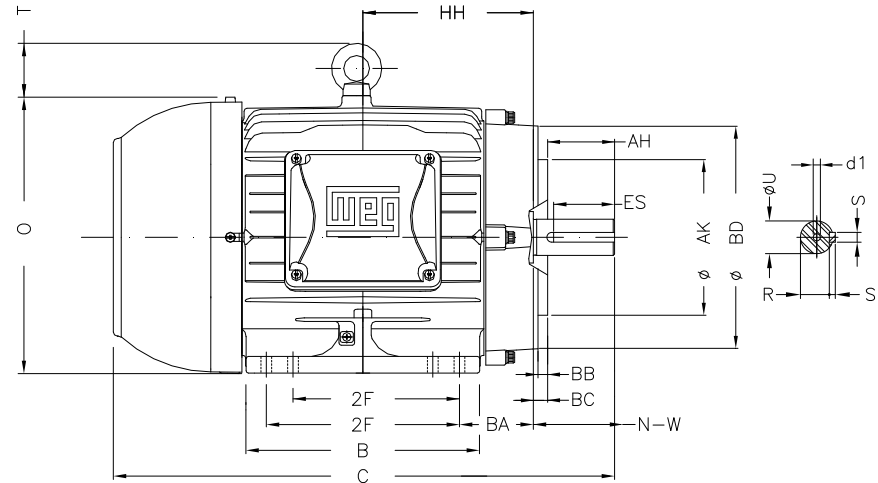
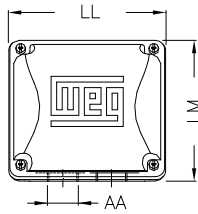
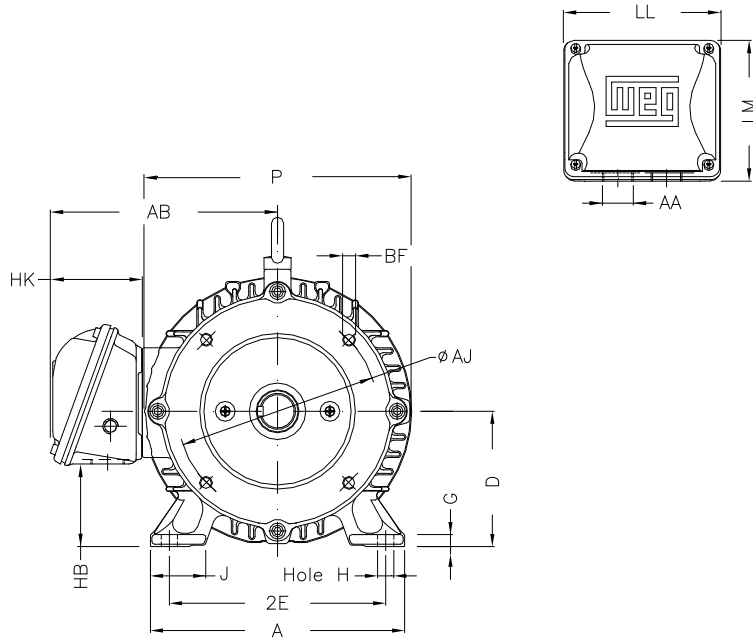

Notes: Downloaded from <http://dealerselectric.com>  
Generated for Model #00536ST3QIE184TC-W22

Performed by:

Checked:

Customer:

Three-Phase: W22 IEEE-841™ Petrochem Motors - NEMA Premium® Efficiency

Three-phase induction motor  
Frame 182/4T - IP55

13-SEP-2016



2E	J	A	P	AB
7.500	1.614	8.661	8.740	7.565
2F	B	BA	U	N-W
4.500/5.500	6.969	2.750	1.125	2.750
ES	S	R	depth	D
1.969	0.250	0.984	0.250	4.500
G	HB	O	T	HF
0.374	2.236	9.400	1.715	4.500
HH	HK	H	C	LL
5.500	3.150	0.406	15.860	5.512
LM	AA	d1	d2	Flange
5.236	NPT 1"	A 4	A 4	FC-184
AJ	AK	BD	BF	BB
7.250	8.500	8.875	UNC 1/2"x13	0.250
BC	AH			
0.125	2.625			