

1 2 3 4 5 6 7 8

A

B

C

D

E

F

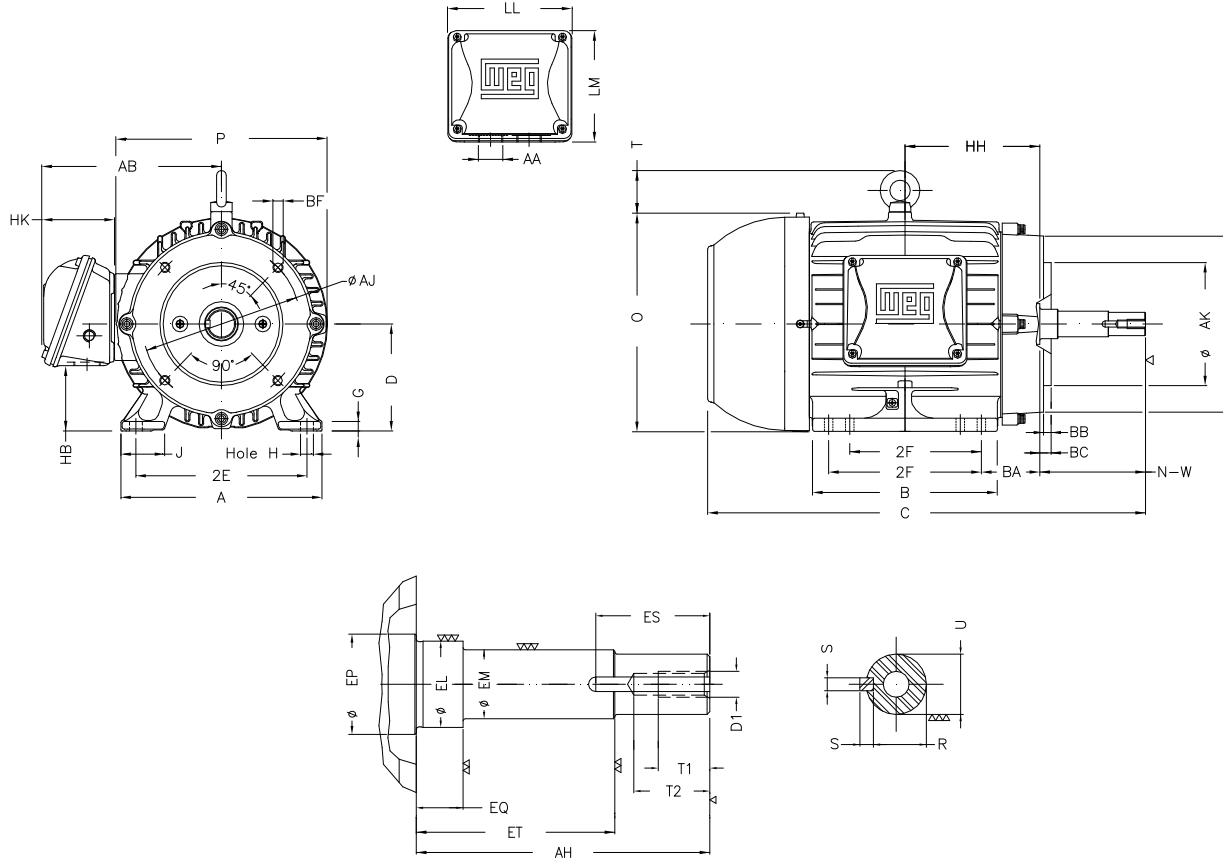

Notes: Downloaded from <http://dealerselectric.com>
Generated for Model #00536ET3H184JM-W22

Performed by:

Checked:

Customer:

Close Coupled Pump: Three-Phase - W22 "JM" Type - TEFC - NEMA Premium

Three-phase induction motor
Frame 182/4JM - IP55

13-SEP-2016



| | | | | |
|-------------------|-------------------|------------------|--------------|--------------------|
| 2E 7.500 | J 1.614 | A 8.661 | P 8.740 | AB 7.565 |
| 2F 4.500/5.500 | B 6.969 | BA 2.750 | D 4.500 | G 0.394 |
| O 9.343 | T 1.772 | H 0.406 | AA NPT 1" | EQ 0.630 |
| ET 2.880 | U 0.874 | EM 1.000 | EL 1.250 | EP 1.376 |
| ES 1.575 | t1 0.748 | t2 1.102 | C 17.411 | d1 EUNC 3/8"-16 |
| HH 5.500 | HK 3.150 | HB 2.236 | LL 5.512 | LM 5.236 |
| S 0.187 | R 0.768 | Flange FC-149 | AJ 5.874 | AK 4.500 |
| BD 6.496 | BF UNC 3/8"x16 | BB 0.157 | AH 4.258 | |