

1 2 3 4 5 6 7 8

A

B

C

D

E

F

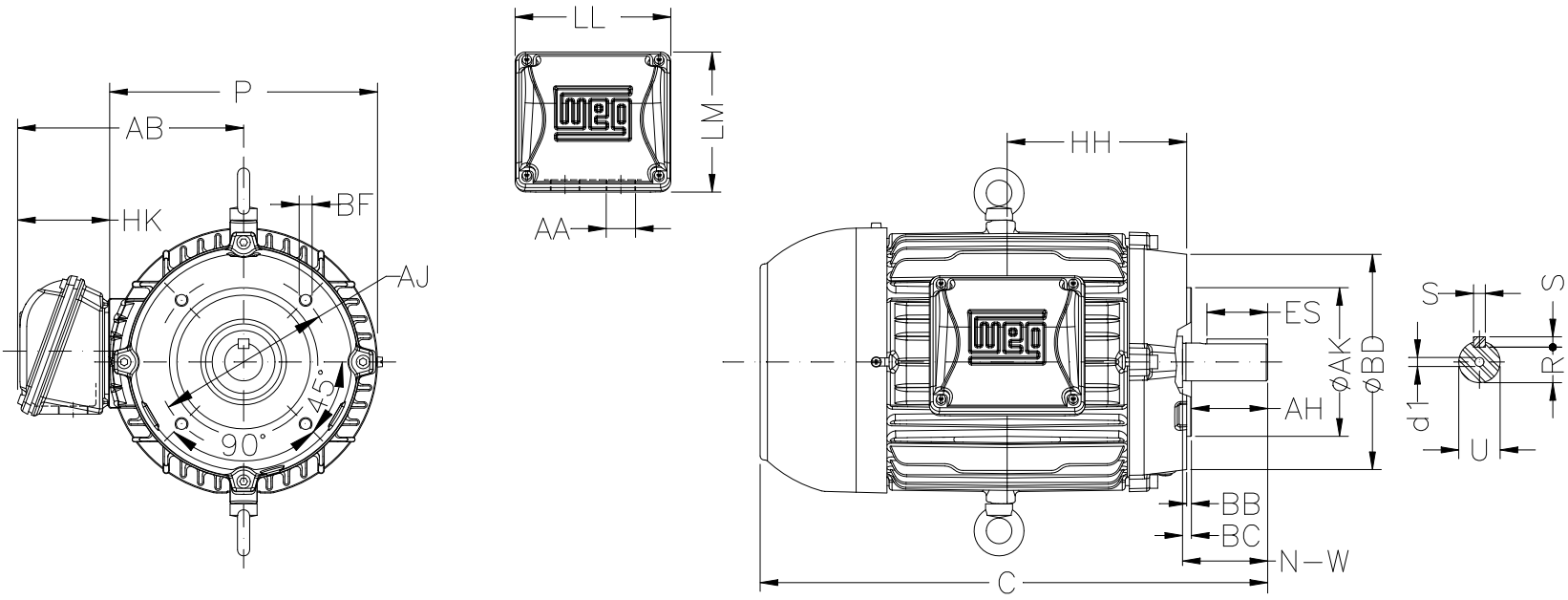

Notes: Downloaded from <http://dealerselectric.com>
Generated for Model #00536EP3ER184TC-W22

Performed by:

Checked:

Customer:

W22 High Efficiency

Three-phase induction motor
Frame 184T - IP55

13-SEP-2016



P	AB	U	N-W	ES
8.937	7.565	1.125	2.750	1.969
S	R	depth	HH	HK
0.250	0.984	0.250	5.500	3.150
C	FC	LL	LM	AA
15.860	18.307	5.512	5.236	NPT 1"
d1	Flange	AJ	AK	BD
A 4	FC-184	7.250	8.500	8.875
BF	BB	BC	AH	
UNC 1/2"x13	0.250	0.125	2.625	