

1 2 3 4 5 6 7 8

A

B

C

D

E

F

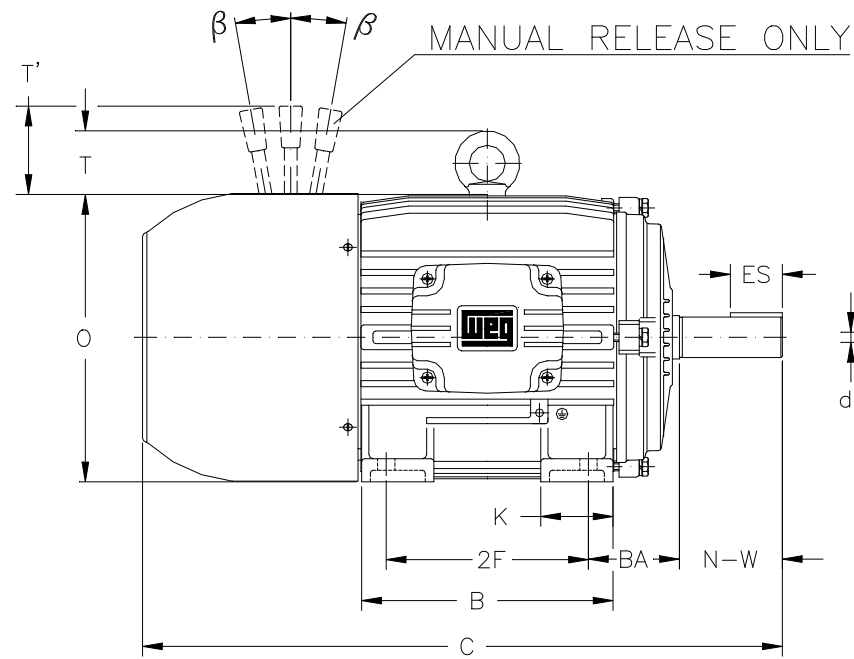
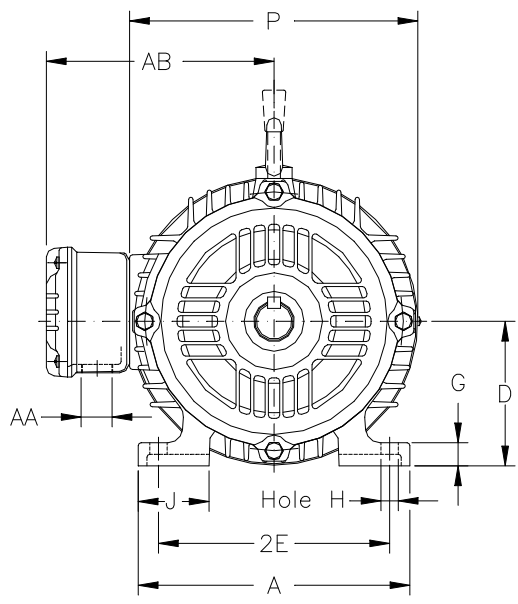

Notes: Downloaded from <http://dealerselectric.com>
Generated for Model #00536EP3EBM184T

Performed by:

Checked:

Customer:

Brake Motors : Three-Phase - High Efficiency

Three-phase induction motor
Frame 184T - IP55

13-SEP-2016



2E 7.500	A 8.661	2F 5.500	B 6.969	BA 2.750
J 1.890	K 1.969	P 8.740	ES 1.969	depth 0.250
S 0.250	N-W 2.750	U 1.125	R 0.984	AB 7.047
D 4.500	G 0.799	O 9.343	T 1.772	H 0.406
C 19.246	AA NPT 1"	d1 A 4	d2 A 4	