

1 2 3 4 5 6 7 8

A

B

C

D

E

F

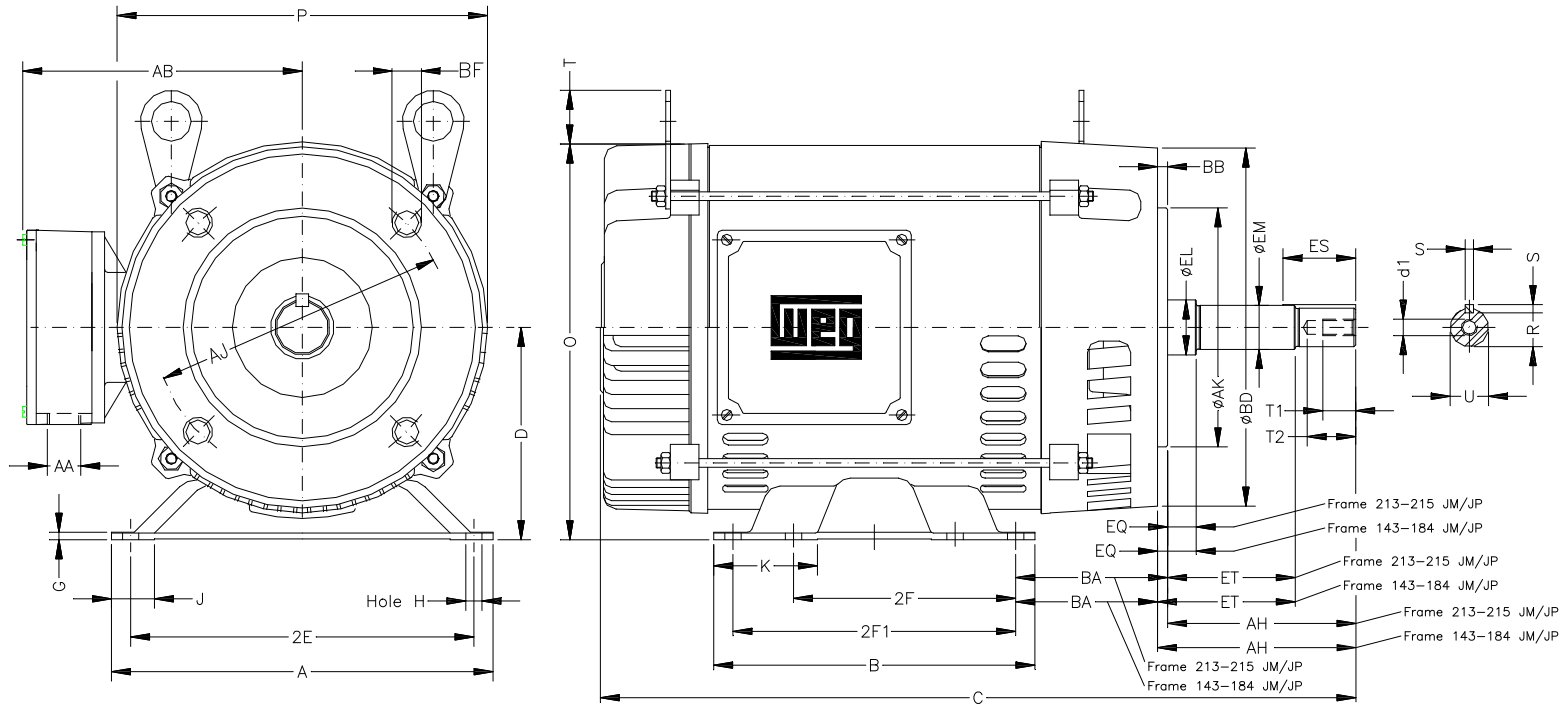

Notes: Downloaded from <http://dealerselectric.com>
Generated for Model #005180P3H184JM

2E 7.500	A 8.661	2F 4.500/5.500	B 6.299	J 1.171
BA 2.750	D 4.500	K 1.988	G 0.187	O 8.307
P 7.637	T 1.614	AB 6.574	H 0.406	AA NPT 3/4"
EQ 0.630	ET 2.880	U 0.874	EM 1.000	EL 1.250
S 0.187	EP 1.376	R 0.767	ES 1.575	d1 EUNC 3/8"-16
t1 0.748	t2 1.102	C 15.315	Flange FC-149	AJ 5.874
AK 4.500	BD 6.496	BF UNC 3/8"x16	BB 0.157	AH 4.258

Performed by:	
Checked:	
Customer:	
Close Coupled Pump : Three-Phase - "JM" Type - ODP - High Efficiency	
Three-phase induction motor Frame 184JM - IP21	13-SEP-2016

