

1 2 3 4 5 6 7 8

A
B
C
D
E
F

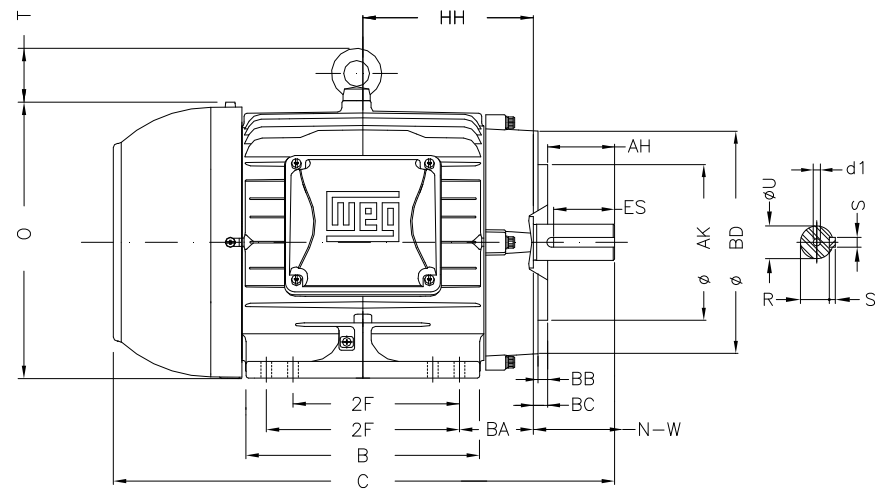
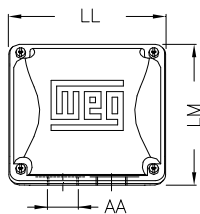
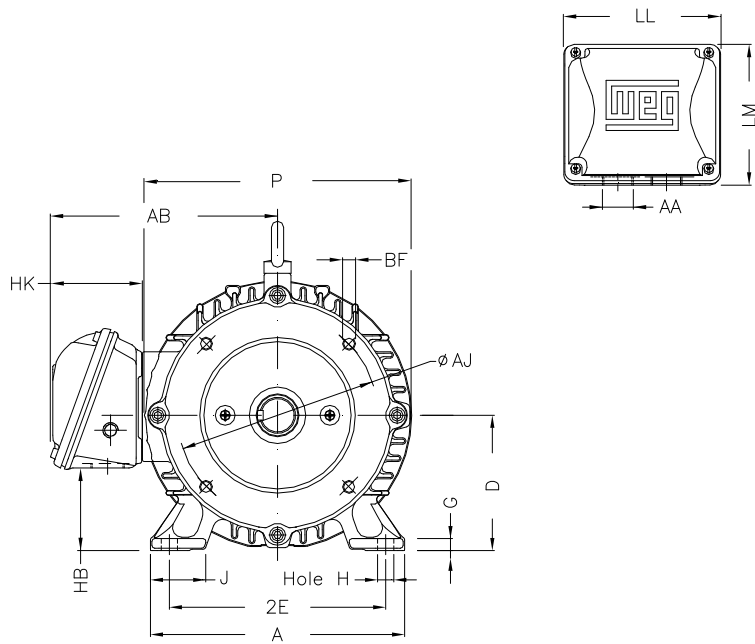

Notes: Downloaded from <http://dealerselectric.com>
Generated for Model #00518ET3H184TC-W22

2E	J	A	P	AB
7.500	1.614	8.661	8.937	7.565
2F	B	BA	FBA	U
4.500/5.500	6.969	2.750	5.057	1.125
N-W	ES	S	R	depth
2.750	1.969	0.250	0.984	0.250
D	G	HB	O	T
4.500	0.394	2.236	9.343	1.772
HF	HH	HK	EV	H
4.500	5.500	3.150	0.734	0.410
C	FC	LL	LM	AA
15.860	18.307	5.512	5.236	NPT 1"
d1	Flange	AJ	AK	BD
A 4	FC-184	7.250	8.500	8.875
BF	BB	BC	AH	
UNC 1/2"x13	0.250	0.125	2.625	

Performed by:
Checked:
Customer:
W22 NEMA Premium - Ball Bearings
Three-phase induction motor
Frame 182/4T - IP55
13-SEP-2016

