

1 2 3 4 5 6 7 8

A

B

C

D

E

F

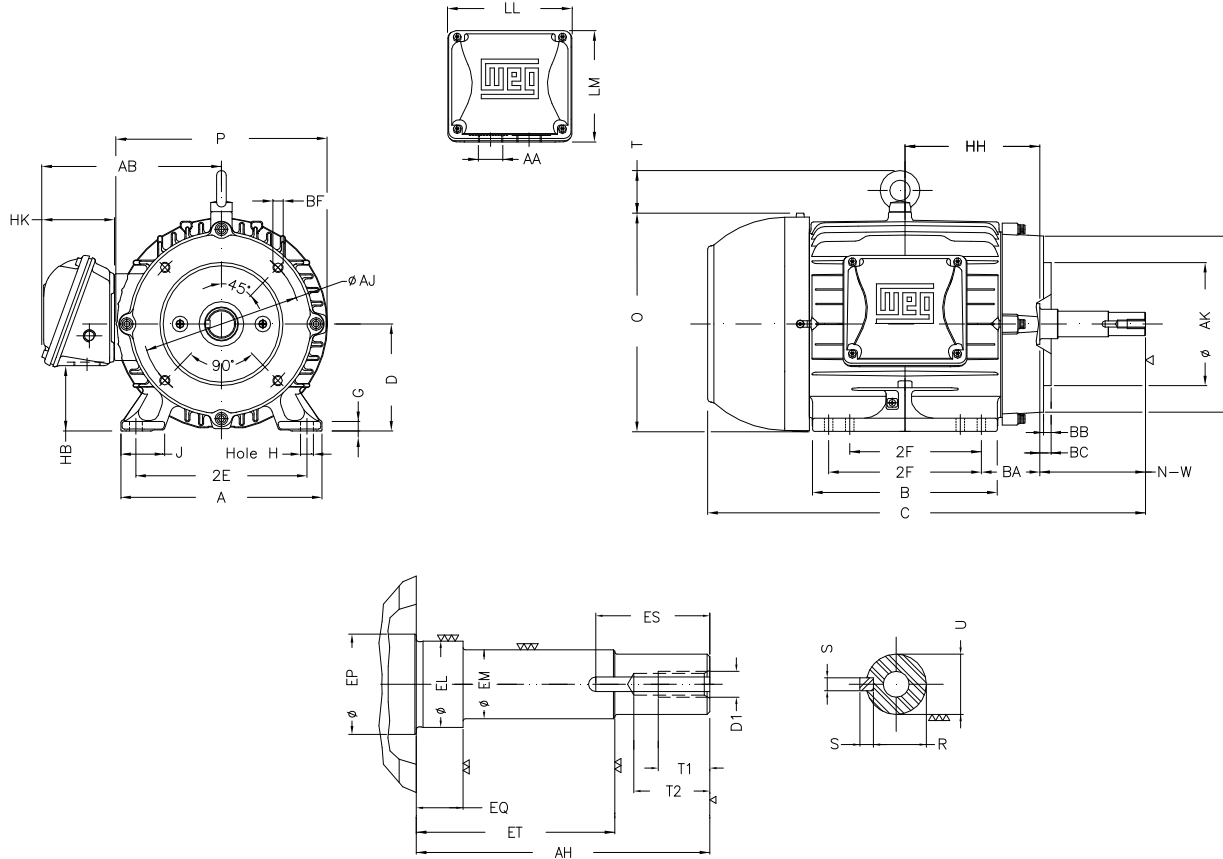

Notes: Downloaded from <http://dealerselectric.com>
Generated for Model #00518ET3H184JP-W22

2E	J	A	P	AB
7.500	1.614	8.661	8.740	7.565
2F	B	BA	D	G
4.500/5.500	6.969	2.750	4.500	0.394
O	T	H	AA	EQ
9.343	1.772	0.406	NPT 1"	1.563
ET	U	EM	EL	EP
5.941	0.874	1.000	1.250	1.376
ES	t1	t2	C	d1
1.575	0.748	1.102	20.475	EUNC 3/8"-16
HH	HK	HB	LL	LM
5.500	3.150	2.236	5.512	5.236
S	R	Flange	AJ	AK
0.187	0.768	FC-149	5.874	4.500
BD	BF	BB	AH	
6.496	UNC 3/8"x16	0.157	7.319	

Performed by:

Checked:

Customer:

Close Coupled Pump: Three-Phase - W22 "JP" Type - TEFC - NEMA Premium

Three-phase induction motor
Frame 182/4JP - IP55

13-SEP-2016

