

1 2 3 4 5 6 7 8

A

B

C

D

E

F

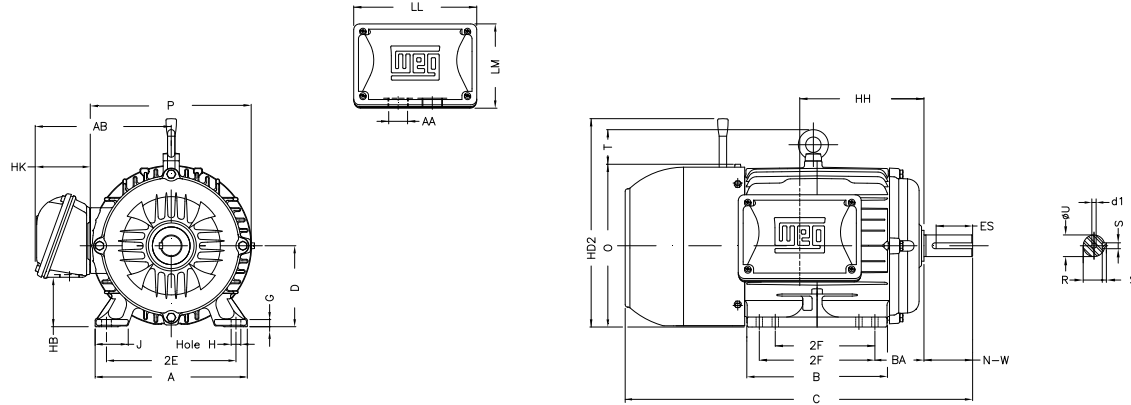

Notes: Downloaded from <http://dealerselectric.com>  
Generated for Model #00518ET3EBM184T-W22

Performed by:

Checked:

Customer:

W22 Brake Motor - NEMA Premium Efficiency

Three-phase induction motor  
Frame 182/4T - IP55

13-SEP-2016



2E 7.500	J 1.614	A 8.661	P 8.740	AB 7.513
2F 4.500/5.500	B 6.969	BA 2.750	U 1.125	N-W 2.750
ES 1.969	S 0.250	R 0.984	D 4.500	G 0.394
HB 2.216	O 9.343	HF 4.500	HH 5.500	HK 3.117
H 0.406	C 19.314	LL 6.575	LM 5.246	AA NPT 1"
HD' 7.728	d1 A 4	HD2 12.138	T 1.772	