

1 2 3 4 5 6 7 8

A

B

C

D

E

F

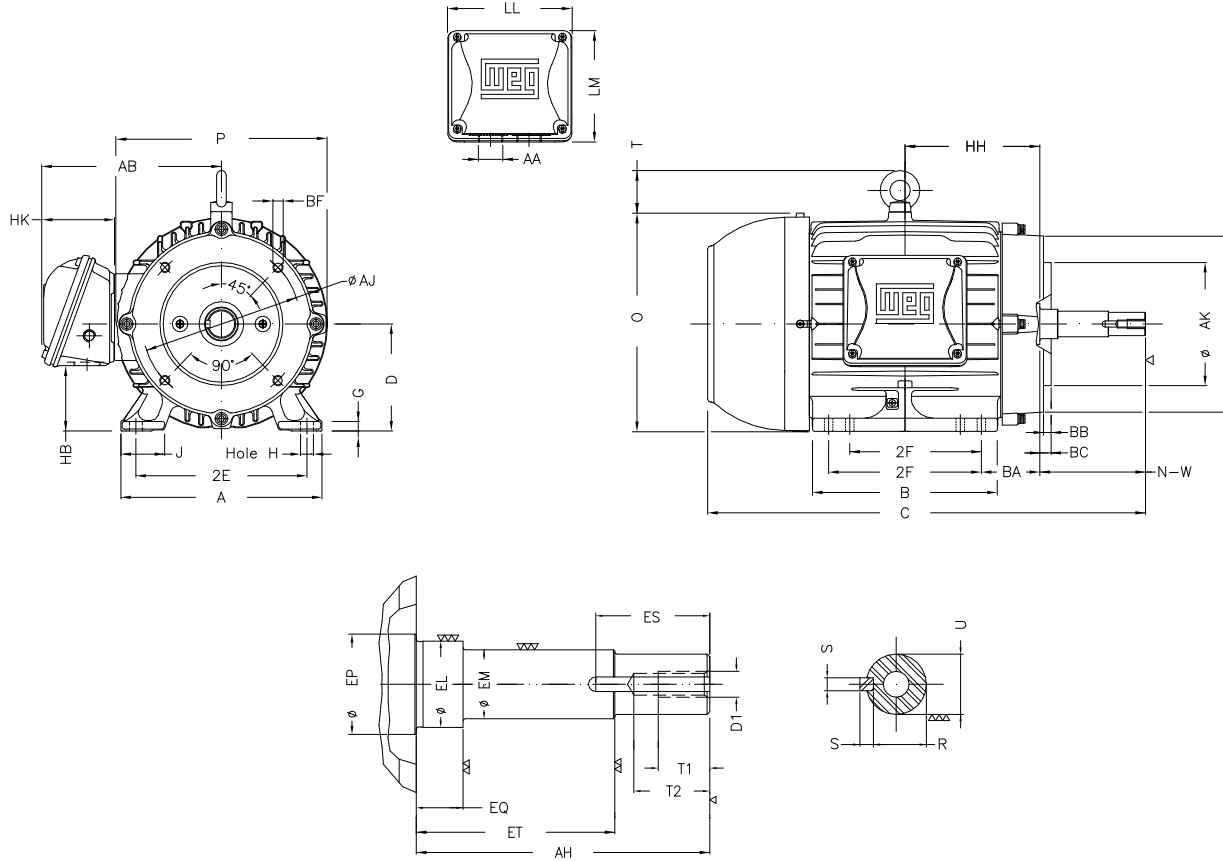

Notes: Downloaded from <http://dealerselectric.com>
Generated for Model #00518EP3E184JM-W22

Performed by:

Checked:

Customer:

Close Coupled Pump: Three-Phase - W22 "JM" Type - TEFC - High Efficiency

Three-phase induction motor
Frame 182/4JM - IP55

13-SEP-2016



2E 7.500	J 1.614	A 8.661	P 8.740	AB 7.565
2F 4.500/5.500	B 6.969	BA 2.750	D 4.500	G 0.394
O 9.343	T 1.772	H 0.406	AA NPT 1"	EQ 0.630
ET 2.880	U 0.874	EM 1.000	EL 1.250	EP 1.376
ES 1.575	t1 0.748	t2 1.102	C 17.411	d1 EUNC 3/8"-16
HH 5.500	HK 3.150	HB 2.236	LL 5.512	LM 5.236
S 0.187	R 0.768	Flange FC-149	AJ 5.874	AK 4.500
BD 6.496	BF UNC 3/8"x16	BB 0.157	AH 4.258	