

1 2 3 4 5 6 7 8

A

B

C

D

E

F

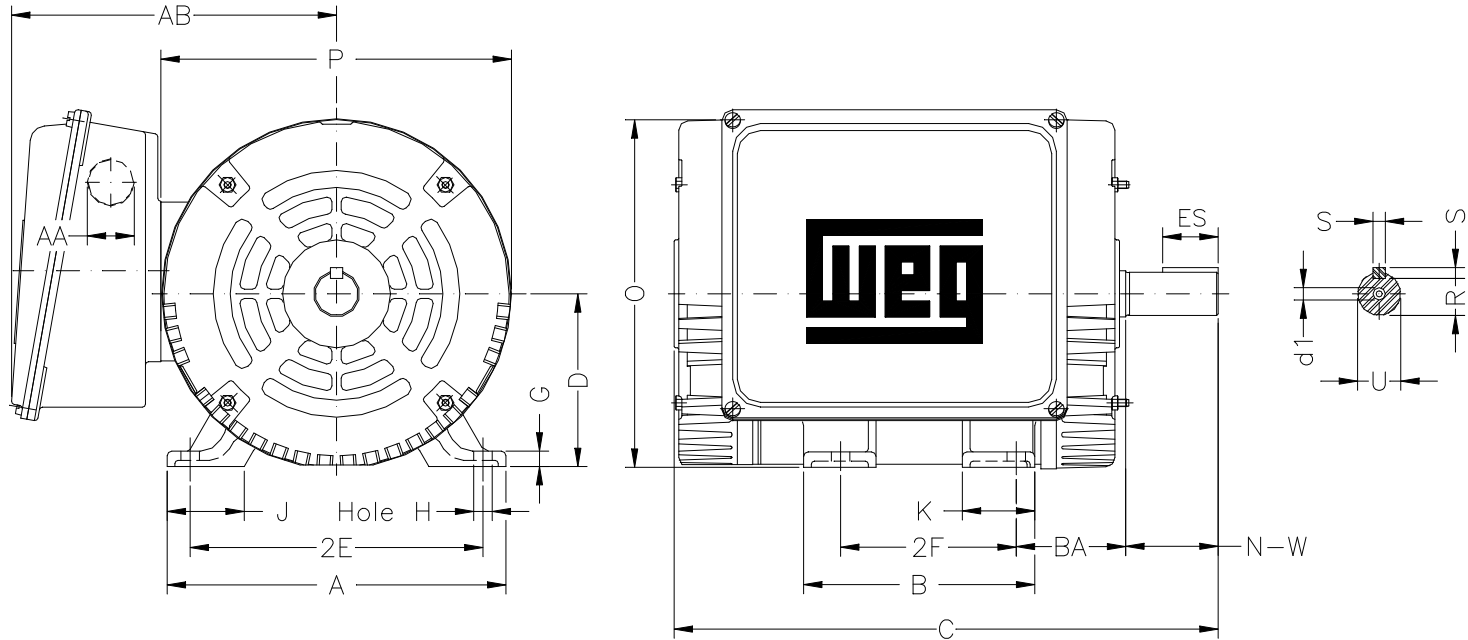

Notes: Downloaded from <http://dealerselectric.com>
Generated for Model #00336OS1D182T

Performed by:

Checked:

Customer:

Single-Phase : ODP (IP22)

Single-phase induction motor
Frame 182T - IP22

13-SEP-2016



2E 7.500	2F 4.500	H 0.406	BA 2.750	A 8.661
B 6.378	C 14.448	D 4.500	G 0.472	J 1.968
K 1.850	O 8.890	P 8.858	ES 1.969	S 0.250
N-W 2.750	U 1.125	R 0.984	AB 8.346	AA NPT 3/4"
d1 A 4				