

1 2 3 4 5 6 7 8

A
B
C
D
E
F

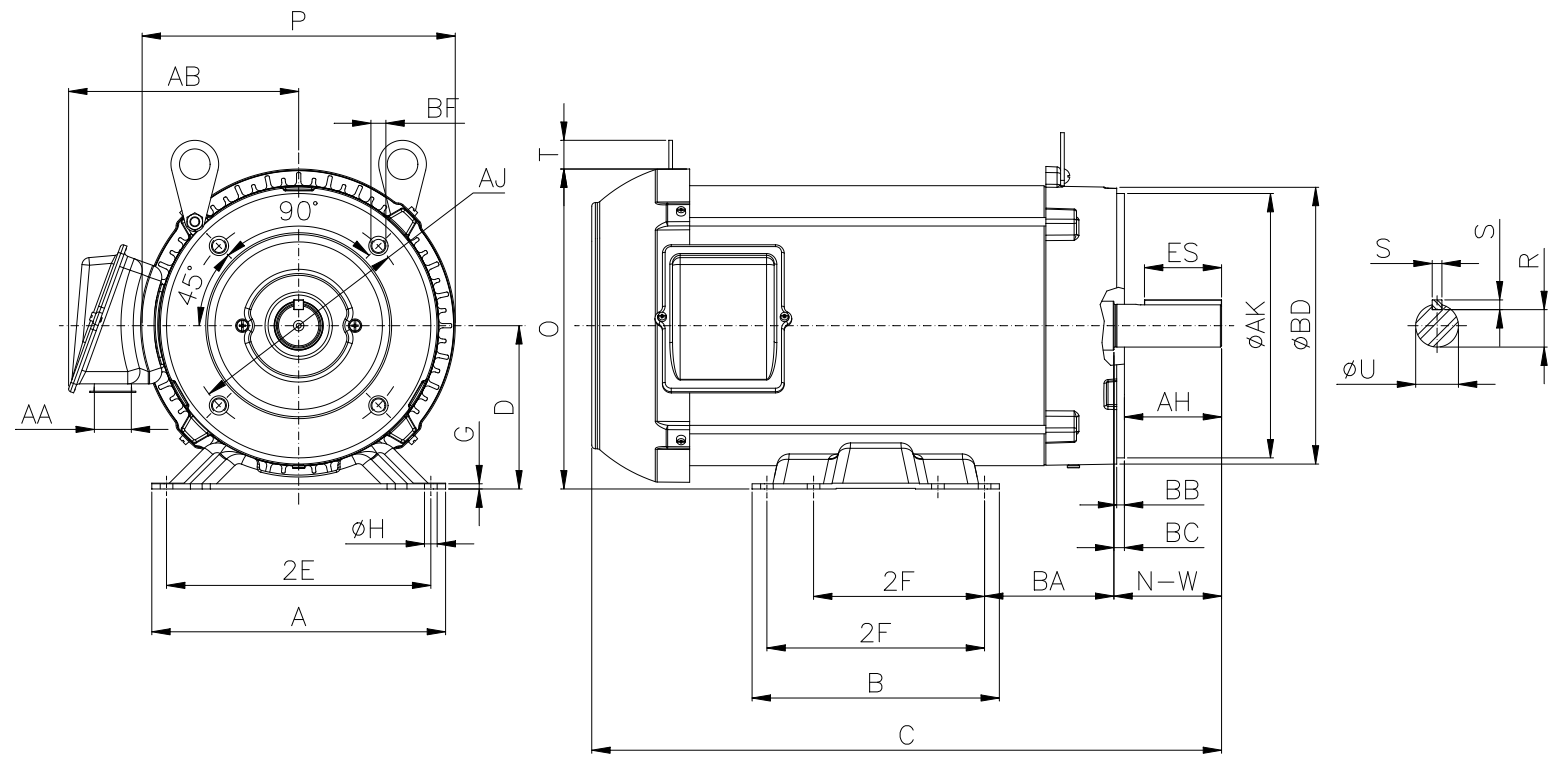

Notes: Downloaded from <http://dealerselectric.com>
Generated for Model #00336ET3ERS182TC

Performed by:

Checked:

Customer:

Three-Phase : Rolled Steel Motor - NEMA Premium Efficiency

2E	A	P	AB	2F
7.500	8.661	8.694	6.353	4.500/5.500
B	BA	U	N-W	ES
6.299	3.500	1.125	2.750	1.969
S	R	depth	D	G
0.250	0.984	0.250	4.500	0.167
O	T	H	C	d1
8.847	0.902	0.406	16.404	A 4
d2	Flange	AJ	AK	BD
A 4	FC-184	7.250	8.500	8.875
BF	BB	BC	AH	
UNC 1/2"x13	0.250	0.125	2.625	

Three-phase induction motor
Frame 182T - IP55

12-SEP-2016

