

1 2 3 4 5 6 7 8

A

B

C

D

E

F

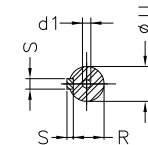
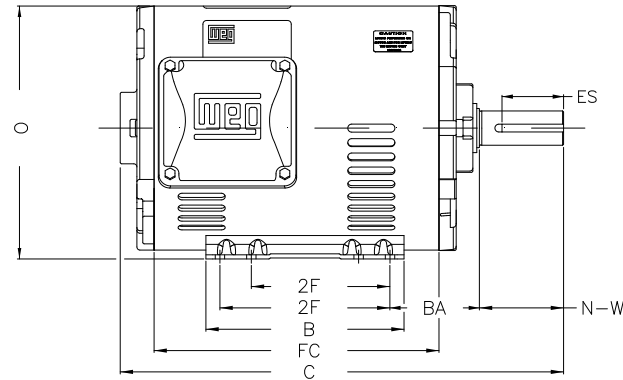
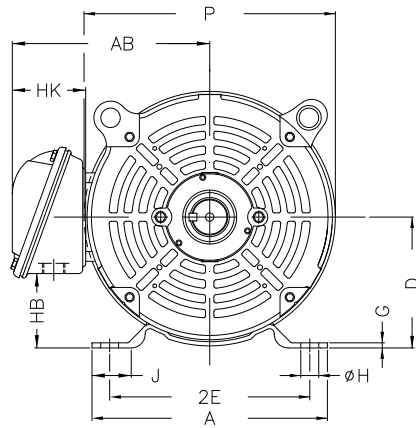
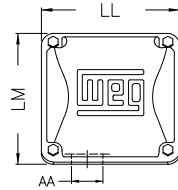

Notes: Downloaded from <http://dealerselectric.com>
Generated for Model #003180T3E182T-S

Performed by:

Checked:

Customer:

Three Phase: W01 (Rolled Steel) - ODP - NEMA Premium Efficiency

Three-phase induction motor
Frame 182/4T - ODP

12-SEP-2016



P	AB	J	2E	A
8.114	6.696	1.299	7.500	8.661
H	G	HB	HK	O
0.406	0.167	2.784	2.629	8.557
FC	2F	B	C	BA
9.055	4.500/5.500	6.299	15.157	2.750
N-W	ES	d1	S	U
2.750	1.969	A 3,15	0.250	1.125
AA	depth	R	LL	LM
1.118"	0.250	0.984	4.563	4.090
BB	D	CH		
0.000	4.500	1.377		