

1 2 3 4 5 6 7 8

A

B

C

D

E

F

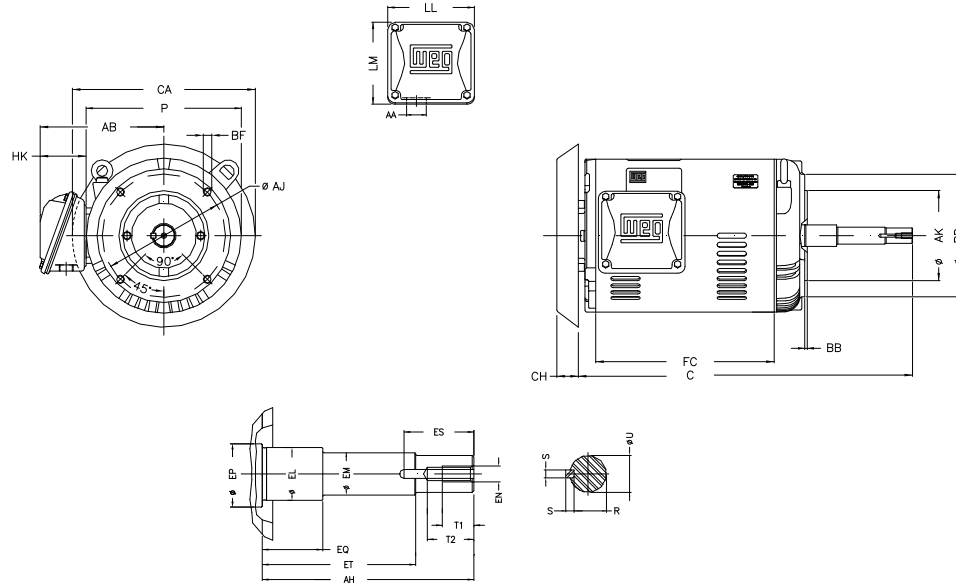

Notes: Downloaded from <http://dealerselectric.com>  
Generated for Model #003180P3E182JMV-S

Performed by:

Checked:

Customer:

Close Coupled Pump: Three-Phase - W01 (Rolled Steel) "JM" Type - ODP - High

Three-phase induction motor  
Frame 182/4JM - ODP

12-SEP-2016



P 8.114	AB 6.696	AA 1.118"	ER 4.258	EQ 0.630
ET 2.880	U 0.8745	EM 1.000	EL 1.250	EP 1.376
ES 1.653	t1 0.748	t2 1.102	C 15.472	FC 7.874
Flange FC-149	AJ 5.874	AK 4.500	BD 6.496	BF UNC 3/8"x16
BB 0.138	AH 4.258			