

1 2 3 4 5 6 7 8

A

B

C

D

E

F

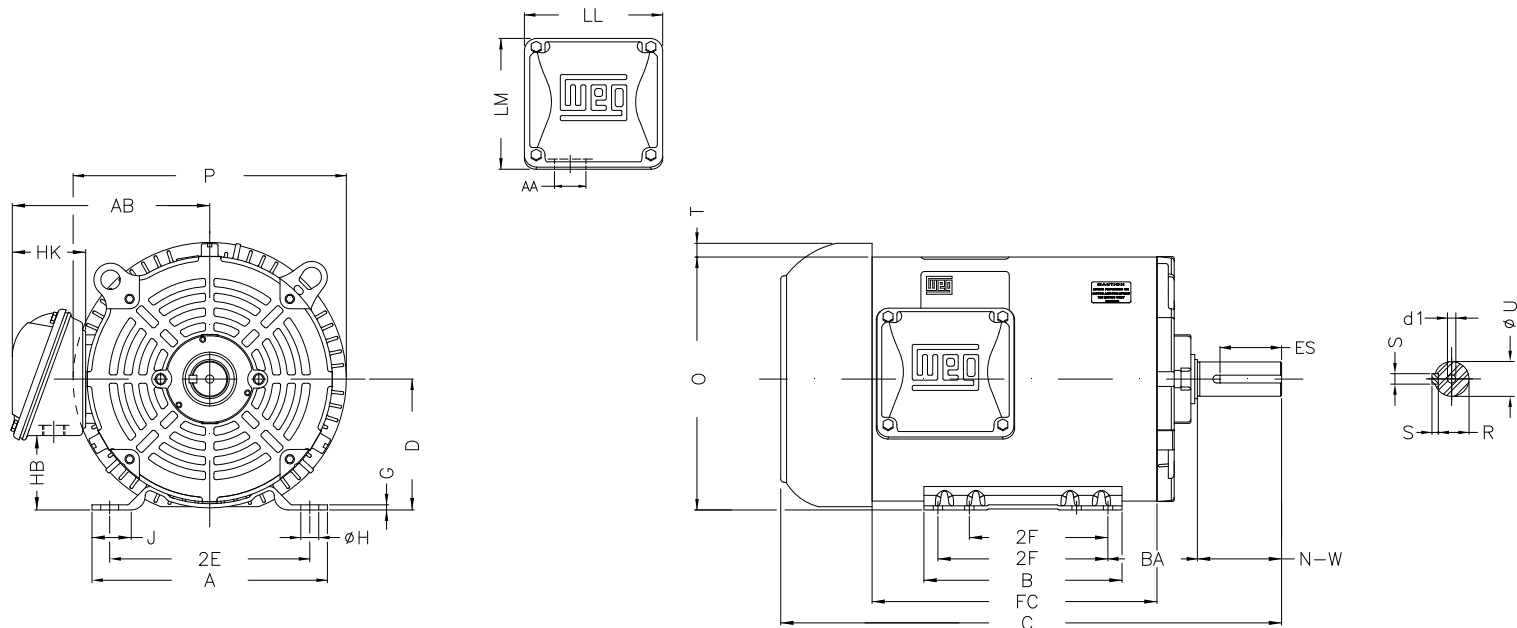

Notes: Downloaded from <http://dealerselectric.com>
Generated for Model #00318ET3H182T-S

Performed by:

Checked:

Customer:

Three Phase: W01 (Rolled Steel) - TEFC - NEMA Premium Efficiency

Three-phase induction motor
Frame 182/4T - IP55

12-SEP-2016



P	AB	J	2E	A
9.435	6.696	1.299	7.500	8.661
H	G	HB	HK	T
0.406	0.167	2.784	2.629	0.661
O	FC	2F	B	C
8.557	10.236	4.500/5.500	6.299	17.913
BA	N-W	ES	d1	S
2.750	2.750	1.969	A 3,15	0.250
U	AA	depth	R	LL
1.125	1.118"	0.250	0.984	4.563
LM	BB	D	CH	
4.090	0.661	4.500	1.377	