

1 2 3 4 5 6 7 8

A

B

C

D

E

F

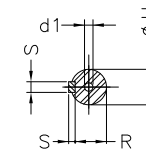
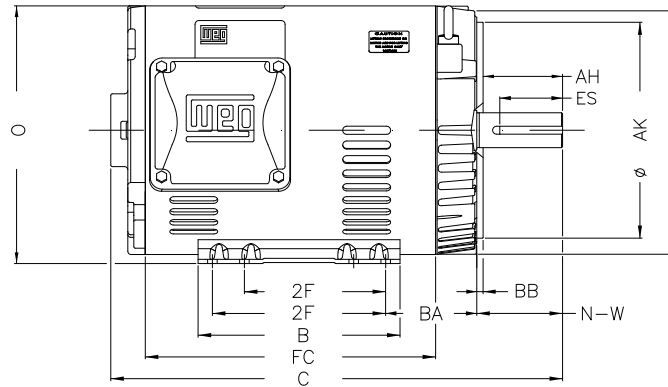
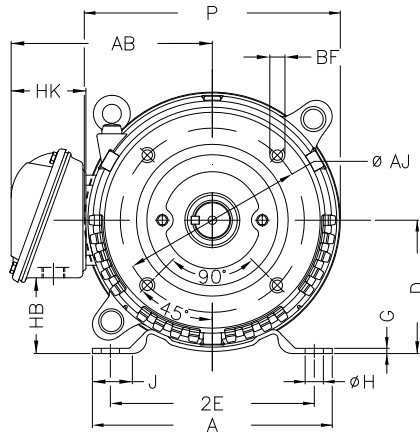
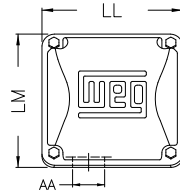

Notes: Downloaded from <http://dealerselectric.com>
Generated for Model #003120T3E213TC-S

P	AB	J	2E	A
9.846	7.973	1.575	8.500	9.449
H	G	HB	HK	T
0.406	0.167	2.982	3.022	0.029
O	FC	2F	B	C
10.144	10.236	5.500/7.000	7.953	16.575
BA	N-W	ES	d1	S
4.250	3.380	2.480	A 4	0.313
U	AA	depth	R	LL
1.375	1.377"	0.313	1.203	5.551
LM	D	CH	Flange	AJ
5.250	5.250	1.929	FC-184	7.250
AK	BD	BF	BB	AH
8.500	9.401	UNC 1/2"x13	0.250	3.129

Performed by:

Checked:

Customer:

Three Phase: W01 (Rolled Steel) - ODP - NEMA Premium Efficiency

Three-phase induction motor
Frame 213/5T - ODP

12-SEP-2016

