

1 2 3 4 5 6 7 8

A

B

C

D

E

F

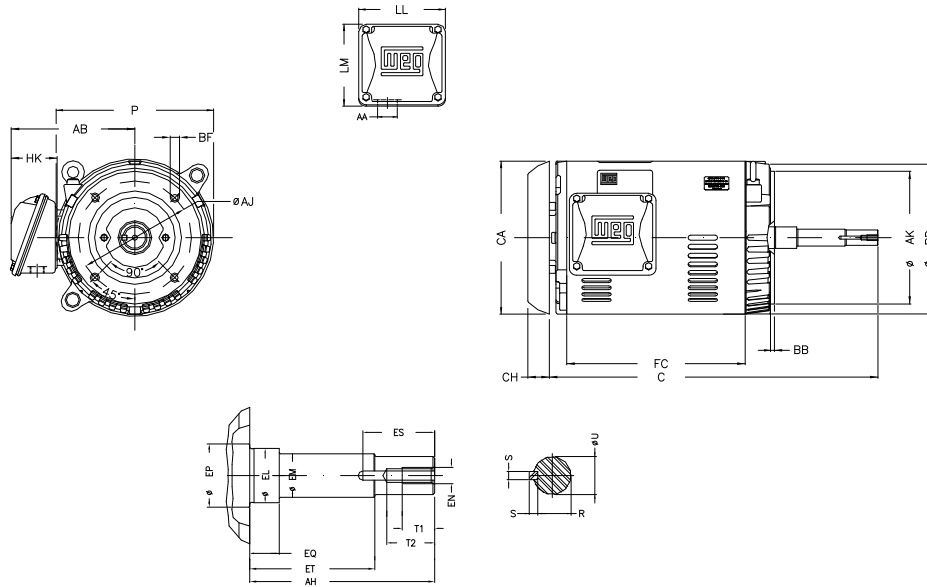

Notes: Downloaded from <http://dealerselectric.com>
Generated for Model #00312OT3E213JMV-S

Performed by:

Checked:

Customer:

Close Coupled Pump: Three-Phase - W01 (Rolled Steel) "JM" Type - ODP -

P	AB	AA	ER	EQ
9.846	7.973	1.377"	4.258	0.630
ET	U	EM	EL	EP
2.880	0.8745	1.000	1.250	1.769
ES	t1	t2	C	FC
1.575	0.748	1.102	17.717	10.236
Flange	AJ	AK	BD	BF
FC-184	7.250	8.500	9.401	UNC 1/2"x13
BB	AH			
0.250	4.258			

Three-phase induction motor
Frame 213/5JM - ODP

12-SEP-2016

