

1 2 3 4 5 6 7 8

A

B

C

D

E

F

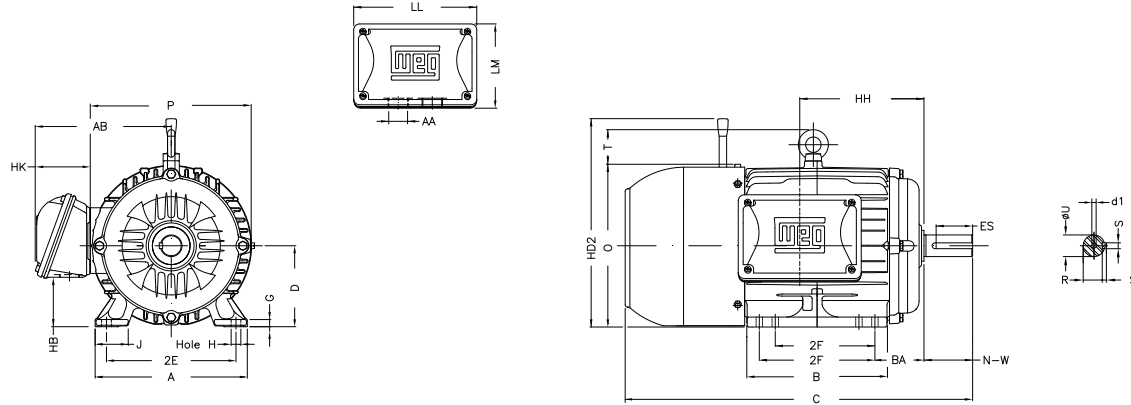

Notes: Downloaded from <http://dealerselectric.com>
Generated for Model #00312ET3EBM213T-W22

Performed by:

Checked:

Customer:

W22 Brake Motor - NEMA Premium Efficiency

Three-phase induction motor
Frame 213/5T - IP55

12-SEP-2016



2E 8.500	J 1.772	A 9.764	P 10.669	AB 8.609
2F 5.500/7.000	K 2.165	B 8.858	BA 3.500	U 1.375
N-W 3.375	ES 2.480	S 0.313	R 1.203	D 5.250
G 0.669	HB 2.966	O 10.841	HF 5.250	HH 7.000
HK 3.117	H 0.406	C 23.188	LL 6.575	LM 5.246
AA NPT 1"	HD' 9.463	d1 A 4	HD2 14.659	T 1.772