

1 2 3 4 5 6 7 8

A  
B  
C  
D  
E  
F

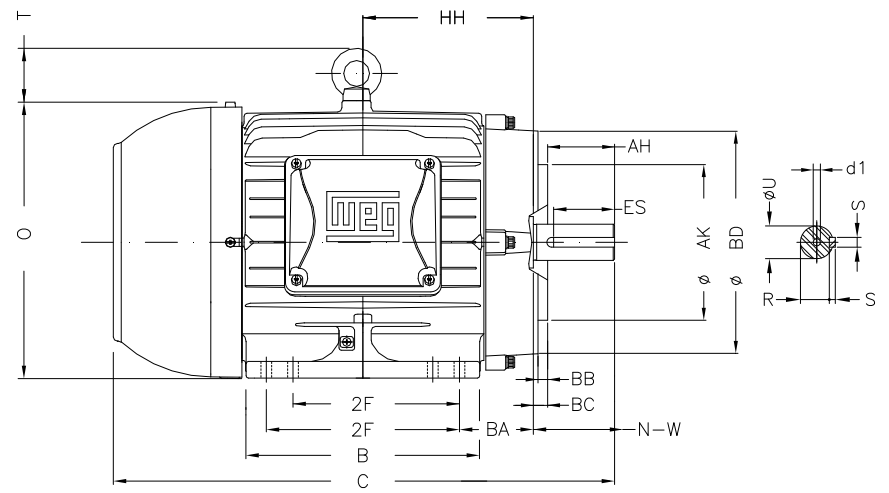
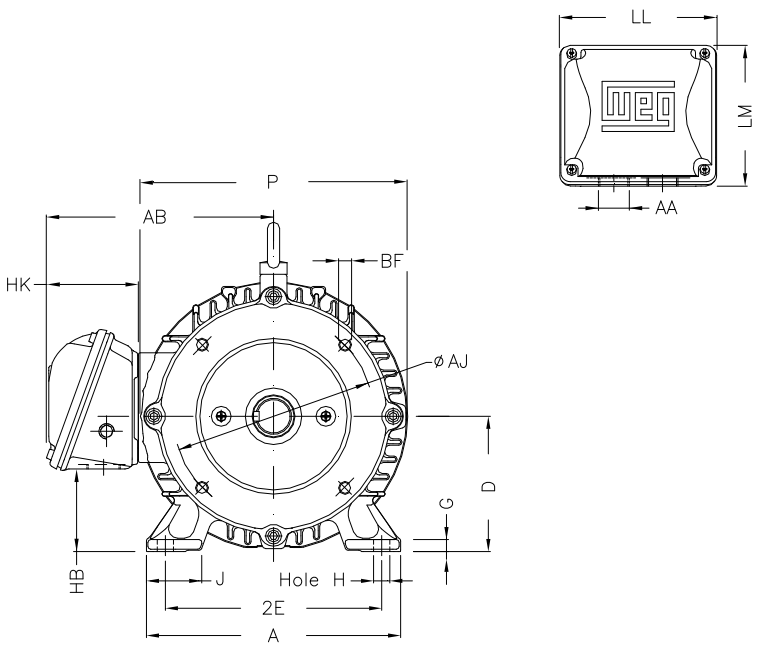

Notes: Downloaded from <http://dealerselectric.com>  
Generated for Model #00309ST3QIE215TC-W22

2E	J	A	P	AB
8.500	1.772	9.764	10.669	8.583
2F	K	B	BA	U
5.500/7.000	2.165	8.858	3.500	1.375
N-W	ES	S	R	depth
3.375	2.756	0.313	1.203	0.313
D	G	HB	O	T
5.250	0.649	2.985	10.841	1.772
HF	HH	HK	H	C
5.250	7.000	3.150	0.406	19.517
LL	LM	AA	d1	d2
5.512	5.236	NPT 1"	A 4	A 4
Flange	AJ	AK	BD	BF
FC-184	7.250	8.500	8.875	UNC 1/2"x13
BB	BC	AH		
0.250	0.250	3.125		

Performed by:  
Checked:  
Customer:  
Three-Phase: W22 IEEE-841™ Petrochem Motors - NEMA Premium® Efficiency  
Three-phase induction motor  
Frame 213/5T - IP55  
12-SEP-2016

