

1 2 3 4 5 6 7 8

A
B
C
D
E
F

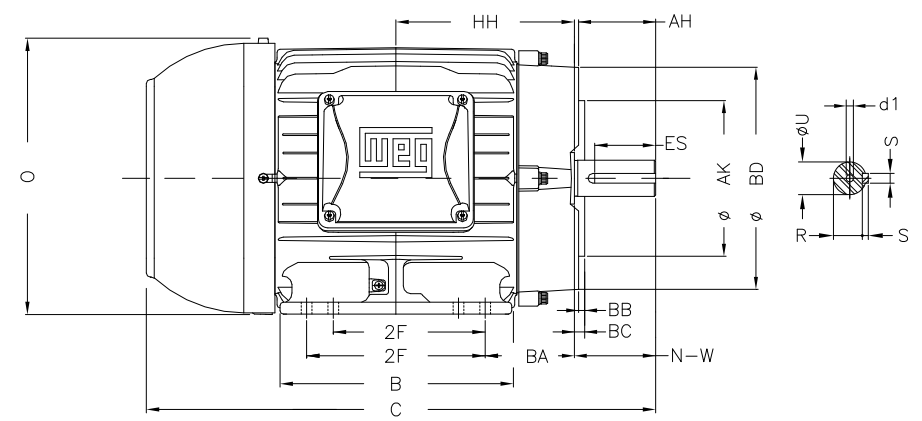
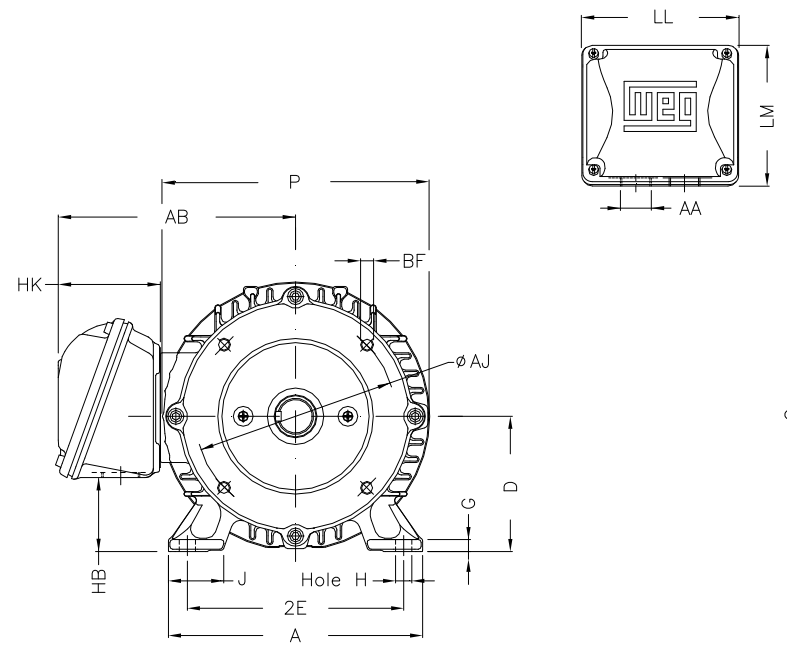

2E	J	A	P	AB
5.500	1.437	6.457	7.047	6.260
2F	B	BA	U	N-W
4.000/5.000	6.142	2.250	0.875	2.250
ES	S	R	depth	D
1.417	0.187	0.771	0.187	3.500
G	HB	O	HF	HH
0.354	1.787	7.122	3.500	4.750
HK	H	C	LL	LM
2.638	0.344	13.346	4.528	4.094
AA	d1	d2	Flange	AJ
NPT 3/4"	A 4	A 4	FC-149	5.875
AK	BD	BF	BB	BC
4.500	6.500	UNC 3/8"x16	0.156	0.125
AH				
2.125				

Notes: Downloaded from <http://dealerselectric.com>
 Generated for Model #00236ST3QIE145TC-W22

Performed by:

Checked:

Customer:

Three-Phase: W22 IEEE-841™ Petrochem Motors - NEMA Premium® Efficiency

Three-phase induction motor
 Frame 143/5T - IP55

12-SEP-2016

