

1 2 3 4 5 6 7 8

A

B

C

D

E

F

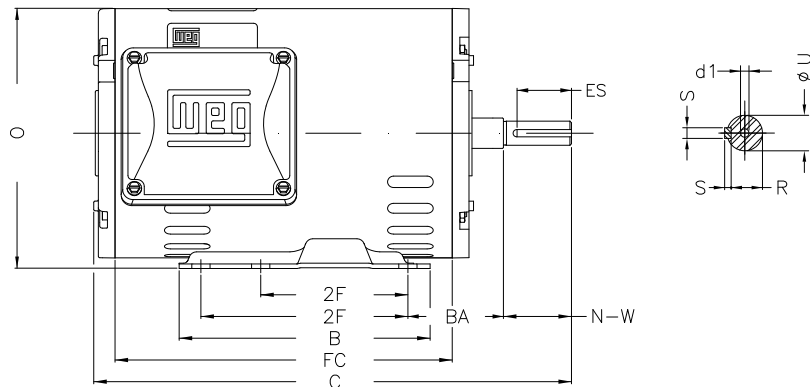
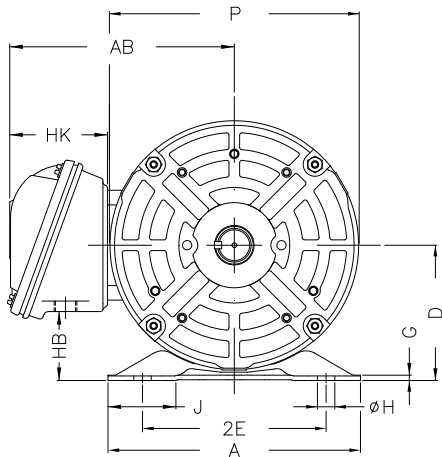
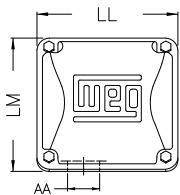

Notes: Downloaded from <http://dealerselectric.com>
Generated for Model #002360T3E145T-S

Performed by:

Checked:

Customer:

Three Phase: W01 (Rolled Steel) - ODP - NEMA Premium Efficiency

Three-phase induction motor
Frame 143/5T - ODP

12-SEP-2016



P	AB	J	2E	A
6.456	5.882	1.732	5.500	6.535
H	G	HB	HK	T
0.343	0.120	1.783	2.638	0.004
O	FC	2F	B	C
6.724	8.268	4.000/5.000	6.496	11.969
BA	N-W	ES	d1	S
2.250	2.250	1.417	A 3,15	0.187
U	AA	depth	R	LL
0.875	1.118"	0.187	0.771	4.543
LM	BB	D	CH	
4.106	0.004	3.500	1.377	