

1 2 3 4 5 6 7 8

A

B

C

D

E

F

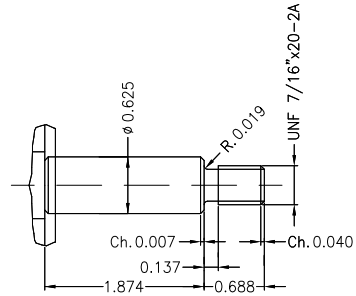
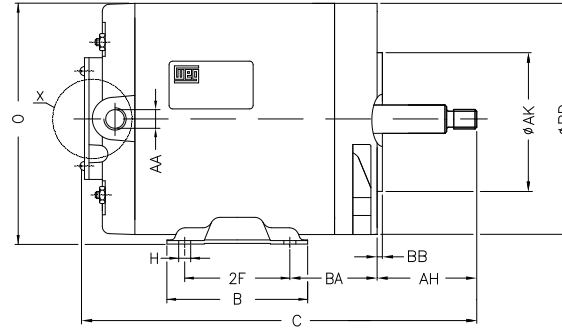
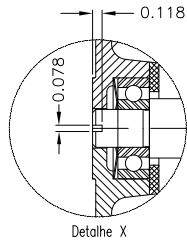
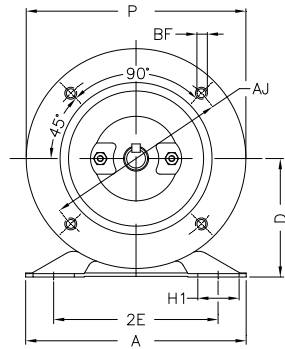

THREE-PHASE, FORM J, WITH INTERNAL THREAD OF 1/4x28 UNF AT SHAFT-END, FOR CLAMPING THE PUMP ROTOR.

Notes: Downloaded from <http://dealerselectric.com>
Generated for Model #00236OS3EJP56J

Performed by:

Checked:

Customer:

Jet Pump - NEMA 56 : Three-Phase - Threaded - ODP (IP21)

Three-phase induction motor
Frame D56 - IP21

12-SEP-2016



2E 4.874	2F 3.000	BA 2.748	A 6.535	B 4.016
C 12.972	D 3.500	G 0.120	O 6.772	P 6.496
N-W 1.874	U 0.625	AA NPT 1/2"	Flange FC-149	AJ 5.874
AK 4.500	BD 6.535	BF 114.3	BB 0.157	AH 2.563