

1 2 3 4 5 6 7 8

A

B

C

D

E

F

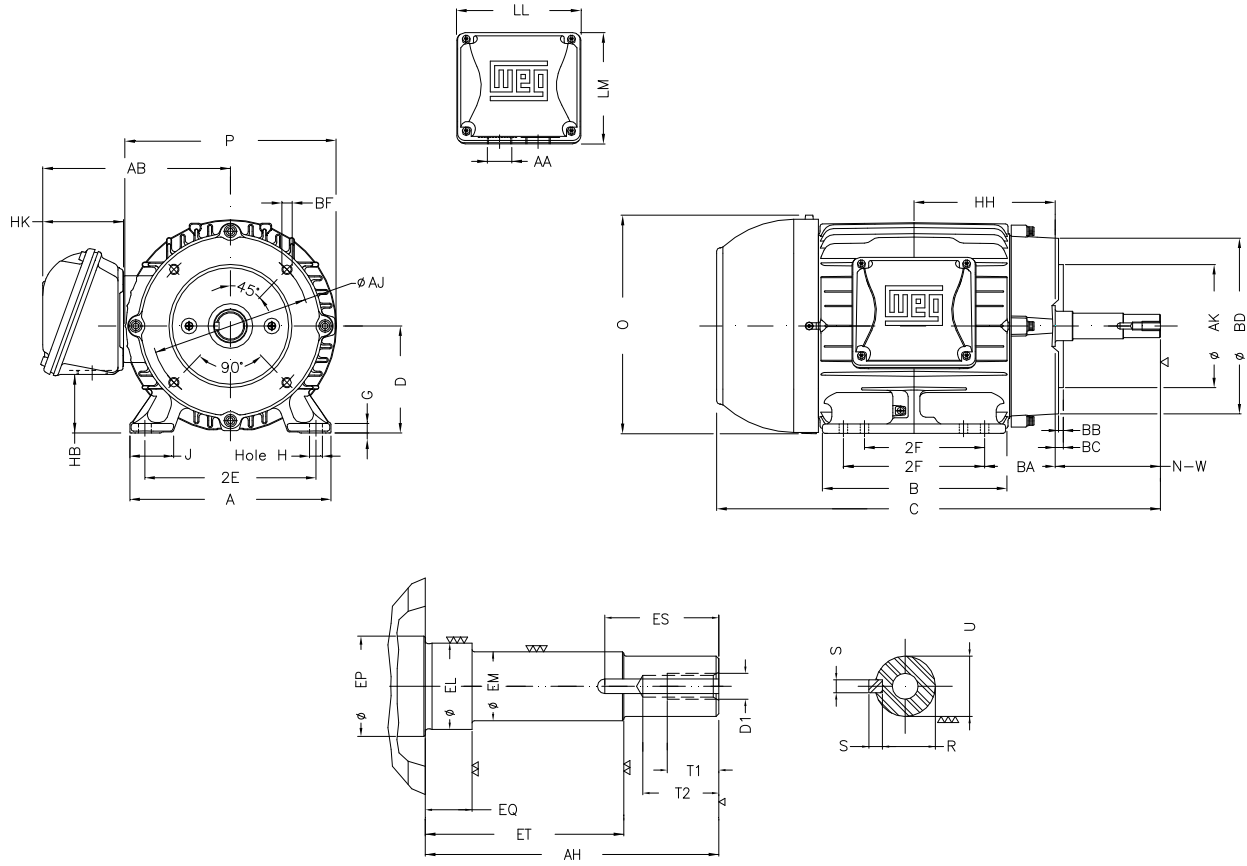

Notes: Downloaded from <http://dealerselectric.com>
Generated for Model #00236ET3H145JM-W22

Performed by:

Checked:

Customer:

Close Coupled Pump: Three-Phase - W22 "JM" Type - TEFC - NEMA Premium

Three-phase induction motor
Frame 143/5JM - IP55

12-SEP-2016



2E 5.500	J 1.437	A 6.457	P 7.047	AB 6.260
2F 4.000/5.000	B 6.142	BA 2.560	D 3.500	G 0.354
O 7.122	H 0.344	AA NPT 3/4"	EQ 0.630	ET 2.880
U 0.874	EM 1.000	EL 1.156	EP 1.179	ES 1.654
t1 0.748	t2 1.102	C 15.675	d1 EUNC 3/8"-16	HH 4.750
HK 2.638	HB 1.787	LL 4.528	LM 4.094	S 0.187
R 0.767	Flange FC-149	AJ 5.874	AK 4.500	BD 6.496
BF UNC 3/8"x16	BB 0.157	AH 4.258		