

1 2 3 4 5 6 7 8

A

B

C

D

E

F

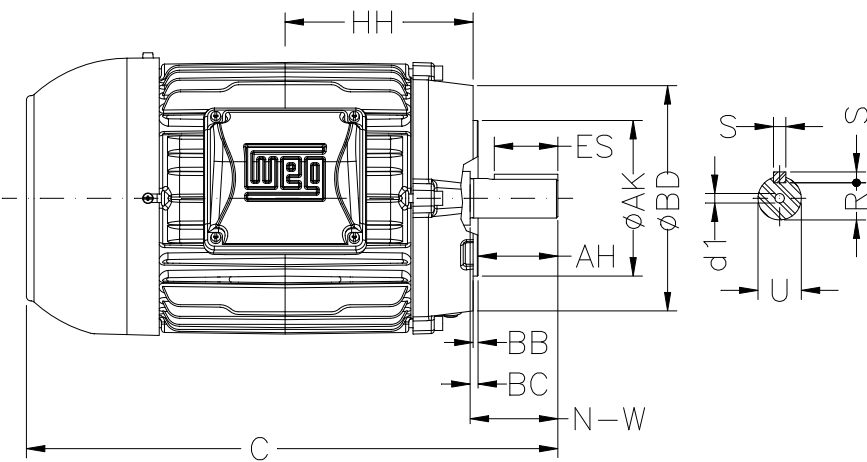
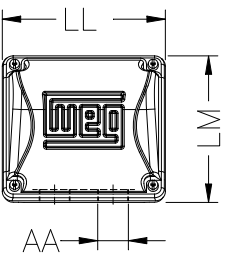
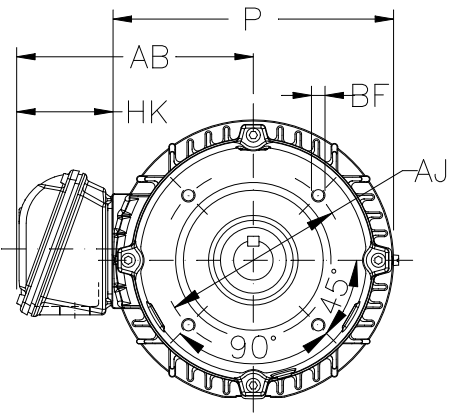

Notes: Downloaded from <http://dealerselectric.com>
Generated for Model #00236EP3ER145TC-W22

Performed by:

Checked:

Customer:

W22 High Efficiency

Three-phase induction motor
Frame 145T - IP55

12-SEP-2016



P	AB	U	N-W	ES
7.244	6.260	0.875	2.250	1.575
S	R	depth	HH	HK
0.187	0.771	0.187	4.750	2.638
C	FC	LL	LM	AA
13.346	15.202	4.528	4.094	NPT 3/4"
d1	Flange	AJ	AK	BD
A 3.15	FC-149	5.875	4.500	6.500
BF	BB	BC	AH	
UNC 3/8"x16	0.157	0.125	2.125	