

1 2 3 4 5 6 7 8

A

B

C

D

E

F

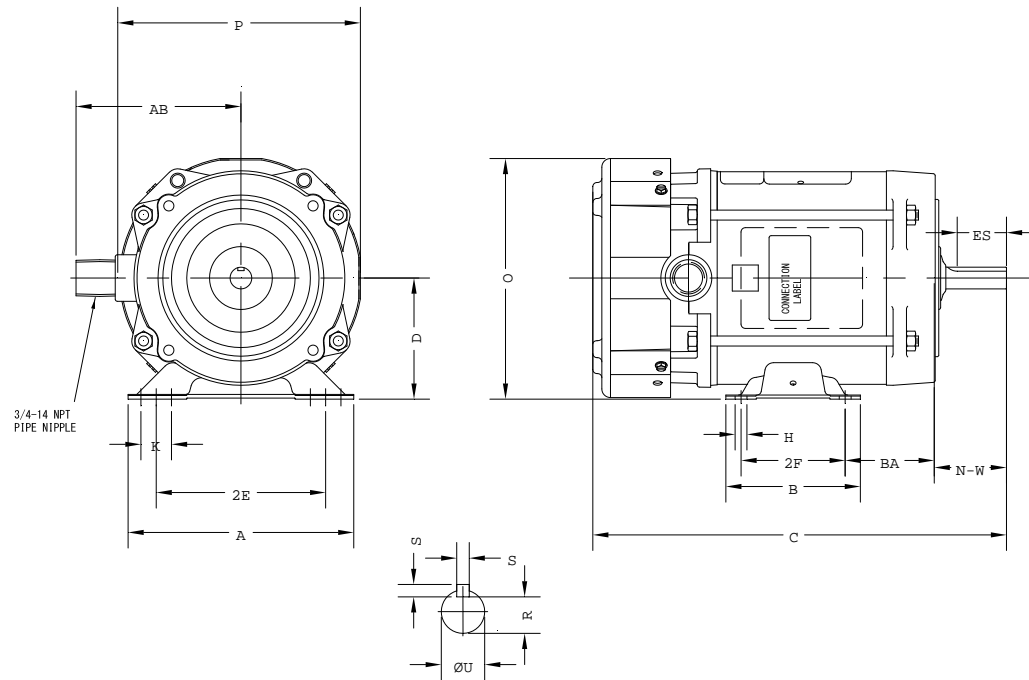

Notes: Downloaded from <http://dealerselectric.com>
Generated for Model #00218XS3E56H

Performed by:

Checked:

Customer:

Three-Phase: Fractional Explosion Proof Motors

Three-phase induction motor
Frame 56H - IP55

12-SEP-2016



2E 4.880	A 6.500	P 6.980	AB 4.500	B 5.880
BA 2.750	U 0.6250	N-W 1.880	ES 1.380	S 0.190
R 0.517	D 3.500	O 6.920	H 0.340	C 15.040
d1 SEM	2F 3.000/5.000			