

1 2 3 4 5 6 7 8

A
B
C
D
E
F

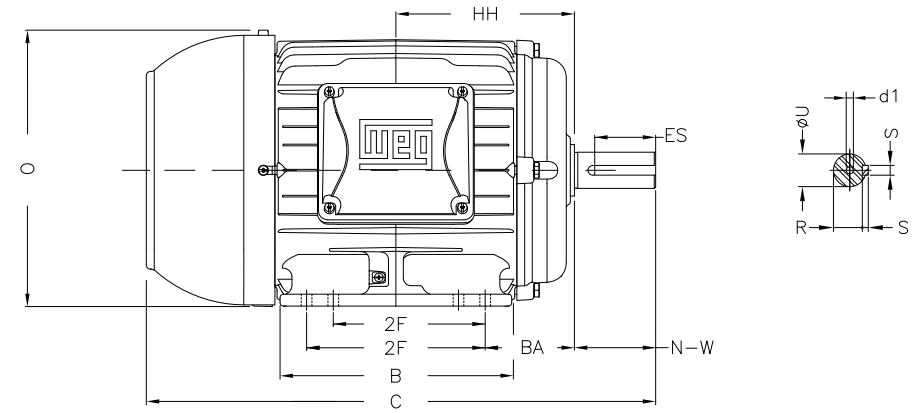
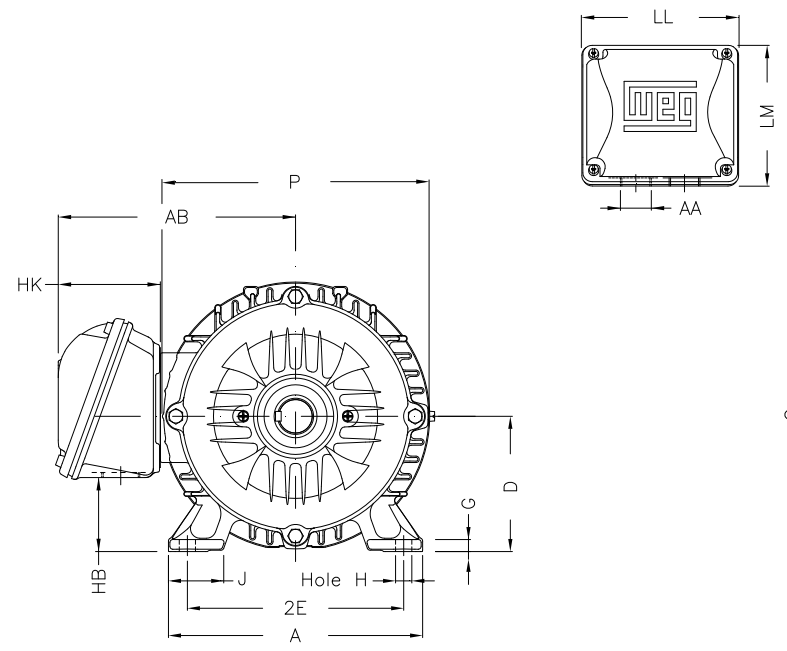

Notes: Downloaded from <http://dealerselectric.com>
Generated for Model #00218ST3QIE145T-W22

Performed by:

Checked:

Customer:

Three-Phase: W22 IEEE-841™ Petrochem Motors - NEMA Premium® Efficiency

2E 5.500	J 1.437	A 6.457	P 7.047	AB 6.260
2F 4.000/5.000	B 6.142	BA 2.250	U 0.875	N-W 2.250
ES 1.417	S 0.187	R 0.771	depth 0.187	D 3.500
G 0.354	HB 1.787	O 7.122	HF 3.500	HH 4.750
HK 2.638	H 0.344	C 13.346	LL 4.528	LM 4.094
AA NPT 3/4"	d1 A 4	d2 A 4		

Three-phase induction motor
Frame 143/5T - IP55

12-SEP-2016

