

1 2 3 4 5 6 7 8

A

B

C

D

E

F

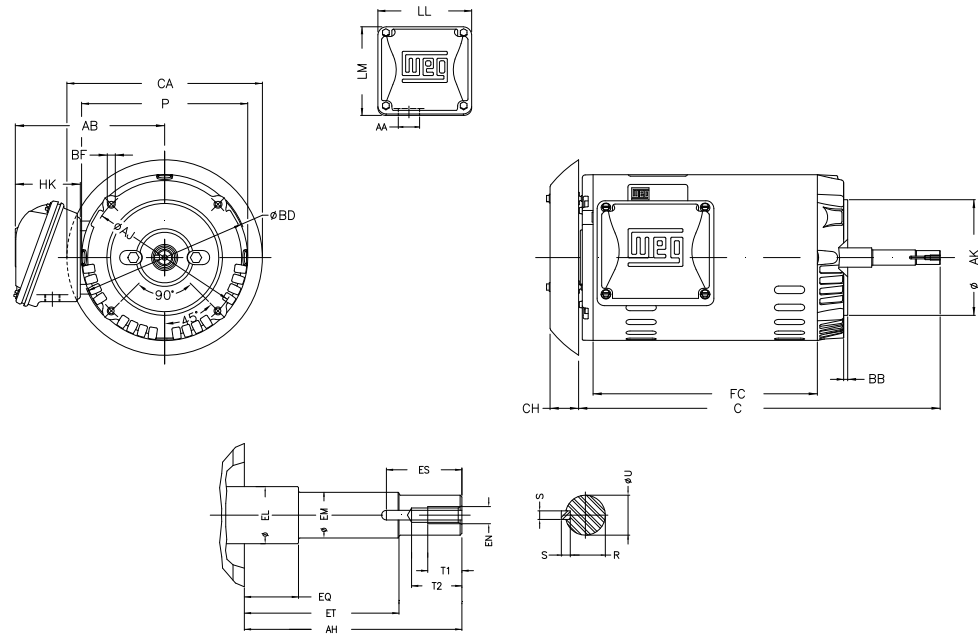

Notes: Downloaded from <http://dealerselectric.com>
Generated for Model #00218OP3E145JMV-S

Performed by:

Checked:

Customer:

Close Coupled Pump: Three-Phase - W01 (Rolled Steel) "JM" Type - ODP - High

Three-phase induction motor
Frame 143/5JM - ODP

12-SEP-2016



P 6.456	AB 5.873	AA 1.118"	ER 4.258	EQ 0.630
ET 2.880	U 0.8745	EM 1.000	EL 1.156	EP 1.179
ES 1.575	t1 0.787	t2 1.102	C 14.488	FC 8.661
Flange FC-149	AJ 5.874	AK 4.500	BD 6.450	BF UNC 3/8"x16
BB 0.157	AH 4.267			