

1 2 3 4 5 6 7 8

A

B

C

D

E

F

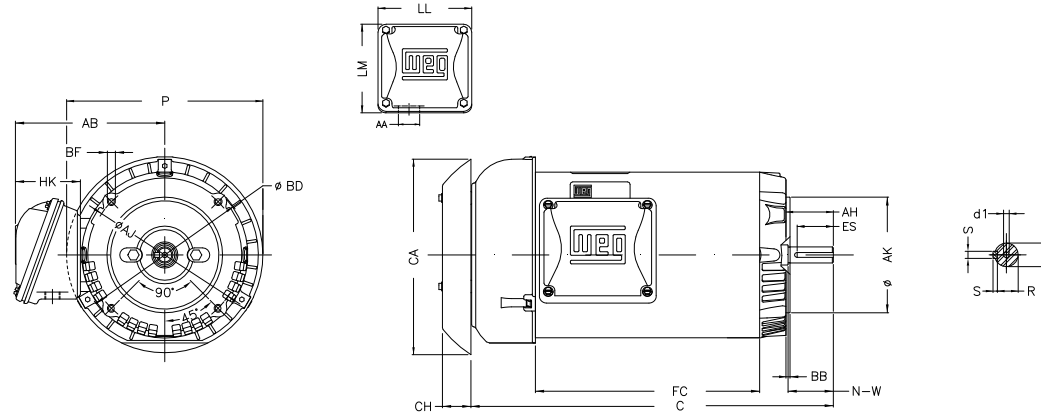

Notes: Downloaded from <http://dealerselectric.com>  
Generated for Model #00218ET3ER145TC-S

Performed by:

Checked:

Customer:

Three Phase: W01 (Rolled Steel) - TEFC - NEMA Premium Efficiency

Three-phase induction motor  
Frame 143/5T - IP55

12-SEP-2016



P	AB	HK	FC	C
7.638	5.882	2.638	8.268	13.976
N-W	ES	d1	S	U
2.250	1.417	A 3.15	0.187	0.875
AA	depth	R	LL	LM
1.118"	0.187	0.771	4.543	4.106
CH	Flange	AJ	AK	BD
1.377	FC-149	5.874	4.500	6.450
BF	BB	AH		
UNC 3/8"x16	0.157	2.132		