

1 2 3 4 5 6 7 8

A

B

C

D

E

F

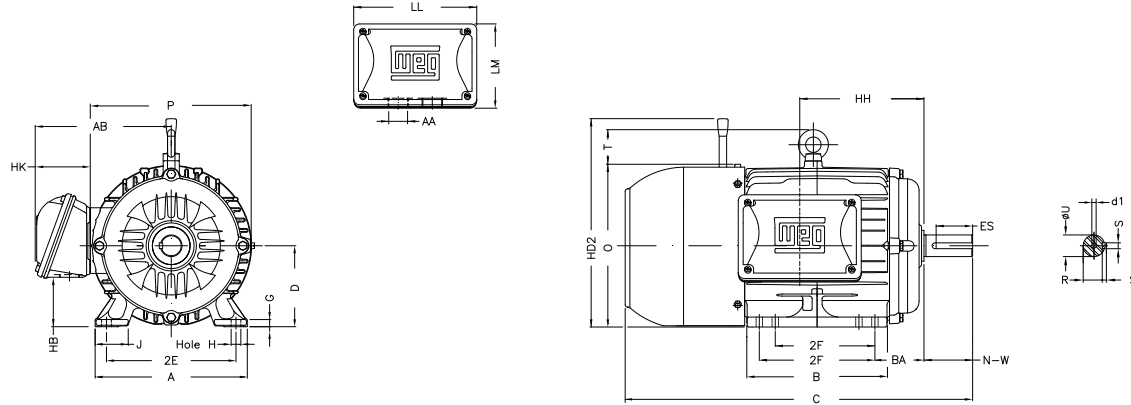

Notes: Downloaded from <http://dealerselectric.com>
Generated for Model #00218ET3EBM145T-W22

Performed by:

Checked:

Customer:

W22 Brake Motor - NEMA Premium Efficiency

Three-phase induction motor
Frame 143/5T - IP55

12-SEP-2016



2E 5.500	J 1.437	A 6.457	P 7.047	AB 6.263
2F 4.000/5.000	B 6.142	BA 2.250	U 0.875	N-W 2.250
ES 1.575	S 0.187	R 0.771	D 3.500	G 0.354
HB 1.727	O 7.122	HF 3.500	HH 4.750	HK 2.733
H 0.344	C 16.231	LL 5.961	LM 4.215	AA NPT 3/4"
HD' 5.154	d1 A 4	HD2 8.697	T 0.000	