

1 2 3 4 5 6 7 8

A
B
C
D
E
F

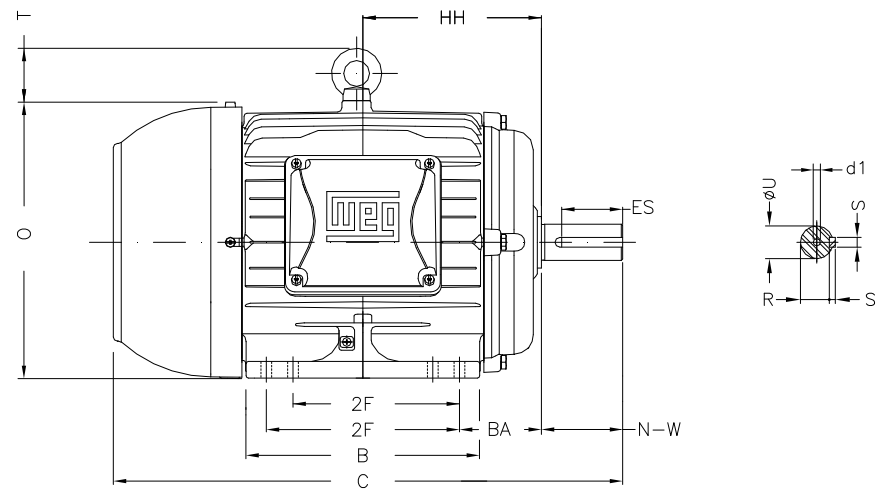
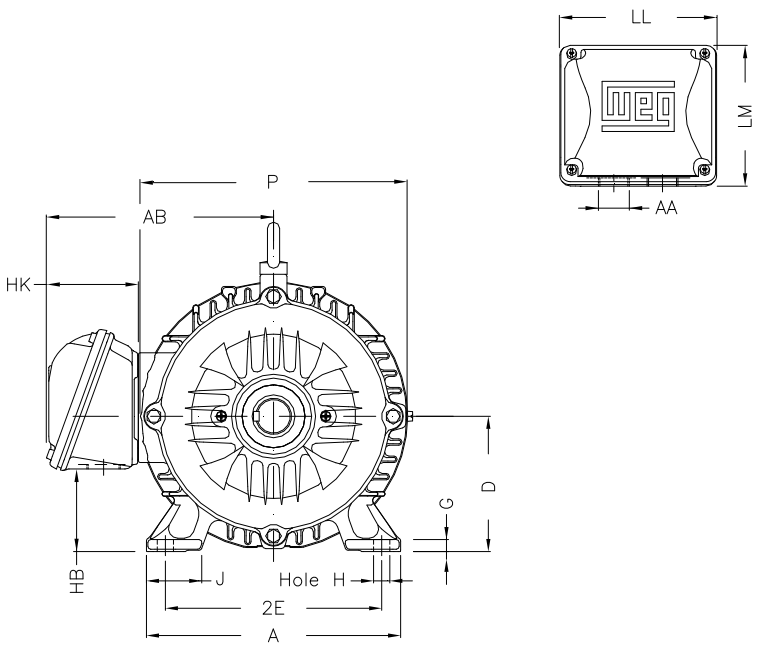

Notes: Downloaded from <http://dealerselectric.com>
Generated for Model #00212ET3H184T-W22

2E 7.500	J 1.614	A 8.661	P 8.937	AB 7.565
2F 4.500/5.500	B 6.969	BA 2.750	FBA 5.057	U 1.125
N-W 2.750	ES 1.969	S 0.250	R 0.984	depth 0.250
D 4.500	G 0.394	HB 2.236	O 9.343	T 1.772
HF 4.500	HH 5.500	HK 3.150	EV 0.734	H 0.410
C 15.860	FC 18.307	LL 5.512	LM 5.236	AA NPT 1"
d1 A 4				

Performed by:
Checked:
Customer:
W22 NEMA Premium - Ball Bearings
Three-phase induction motor
Frame 182/4T - IP55
12-SEP-2016

