

1 2 3 4 5 6 7 8

A

B

C

D

E

F

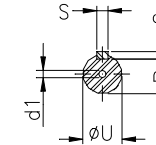
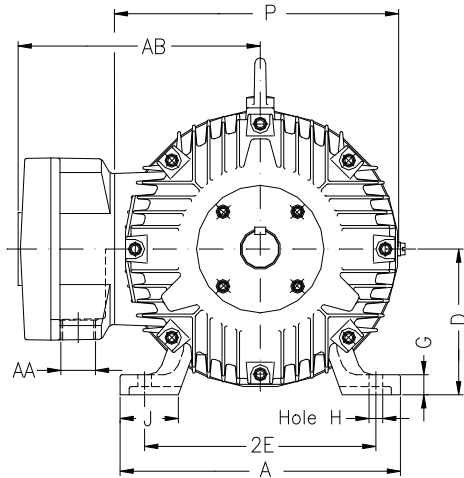

Notes: Downloaded from <http://dealerselectric.com>
Generated for Model #00209XT3E213T

Performed by:

Checked:

Customer:

Three-Phase : Explosion Proof - NEMA Premium

Three-phase induction motor
Frame 213T - IP55

12-SEP-2016



2E 8.500	A 9.764	2F 5.500	B 7.402	BA 3.500
J 2.008	K 2.165	P 10.709	ES 2.480	depth 0.313
S 0.313	N-W 3.375	U 1.375	R 1.203	AB 9.252
D 5.250	G 0.827	O 11.156	T 1.772	H 0.406
C 17.952	AA NPT 1"	d1 A 4	d2 A 4	