

1 2 3 4 5 6 7 8

A

B

C

D

E

F

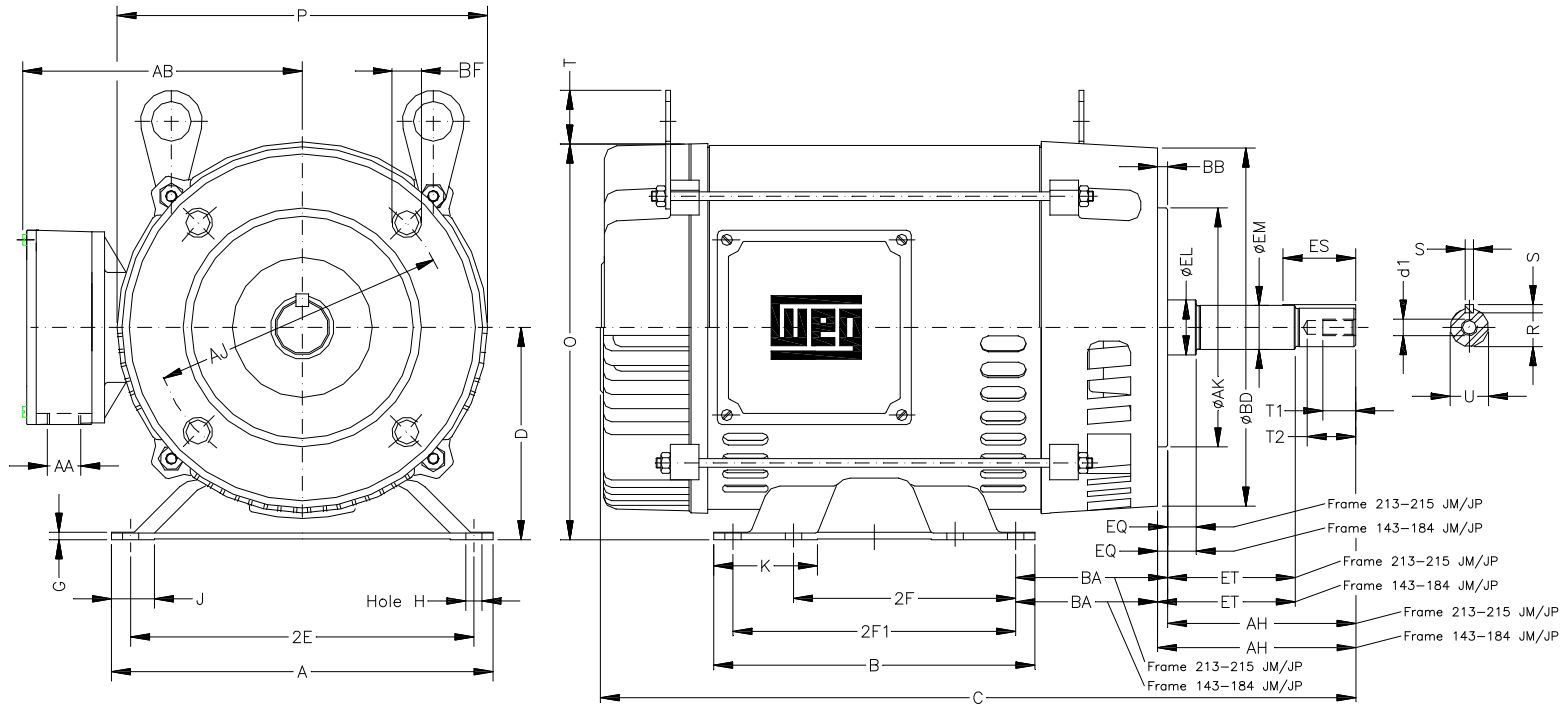

Notes: Downloaded from <http://dealerselectric.com>  
Generated for Model #00158OP3E145JM

2E 5.500	A 6.535	2F 0.157	B 0.256	J 1.732
BA 2.250	D 3.500	G 0.120	O 6.772	P 6.535
AB 5.433	H 0.342	AA 2xNPT 1/2"	EQ 0.630	ET 2.880
U 0.8744	EM 1.000	EL 1.156	S 0.187	R 0.768
ES 1.653	d1 DUNC 3/8"-16	t1 0.748	t2 1.102	C 14.055
Flange FC-149	AJ 5.874	AK 4.500	BD 6.535	BF UNC 3/8"x16
BB 0.157	AH 4.258			

Performed by:	
Checked:	
Customer:	
Close Coupled Pump : Three-Phase - "JM" Type - ODP - High Efficiency	
Three-phase induction motor Frame E143/5JM - IP21	12-SEP-2016

