

1 2 3 4 5 6 7 8

A

B

C

D

E

F

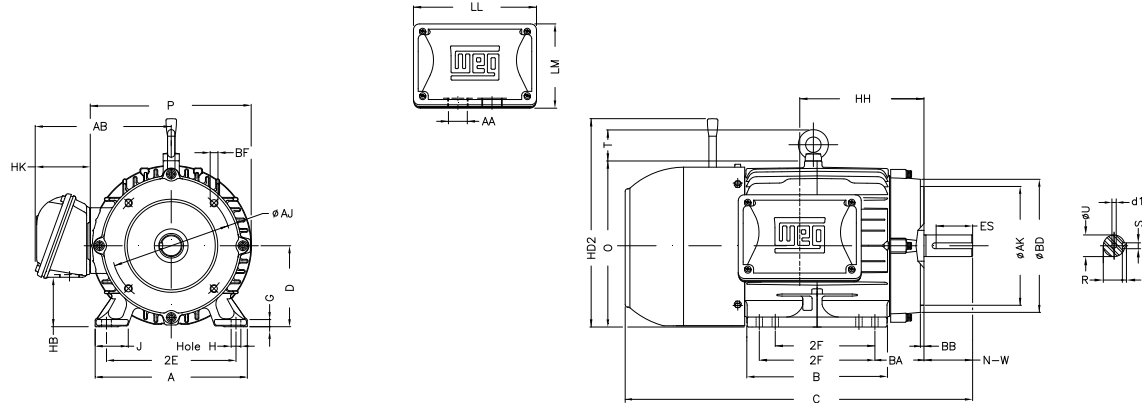

Notes: Downloaded from <http://dealerselectric.com>
Generated for Model #00158ET3EBMQ145TC-W2

2E	J	A	P	AB
5.500	1.437	6.457	7.047	6.263
2F	B	BA	U	N-W
4.000/5.000	6.142	2.250	0.875	2.250
ES	S	R	D	G
1.575	0.187	0.771	3.500	0.354
HB	O	HF	HH	HK
1.727	7.122	3.500	4.750	2.733
H	C	LL	LM	AA
0.344	16.231	5.961	4.215	NPT 3/4"
HD'	d1	HD2	T	Flange
5.154	A 4	8.697	0.000	FC-149
AJ	AK	BD	BF	BB
5.875	4.500	6.500	UNC 3/8"x16	0.156
BC	AH			
0.125	2.125			

Performed by:

Checked:

Customer:

W22 Brake Motor - NEMA Premium Efficiency

Three-phase induction motor
Frame 143/5T - IP55

12-SEP-2016

