

1 2 3 4 5 6 7 8

A
B
C
D
E
F

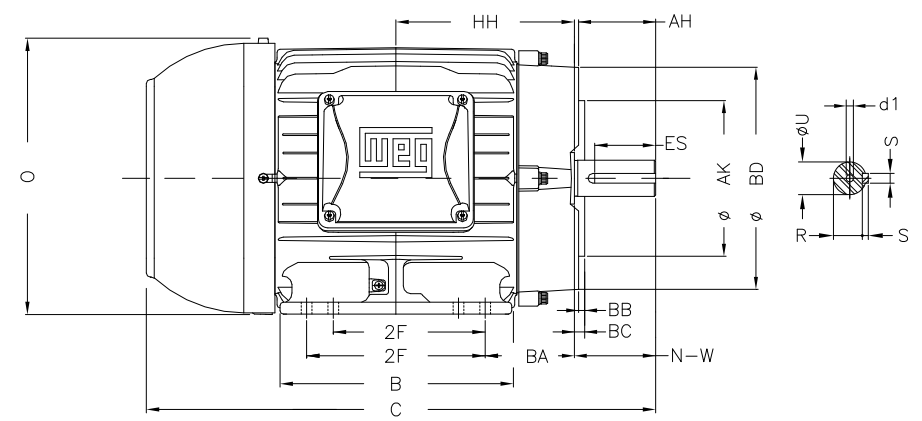
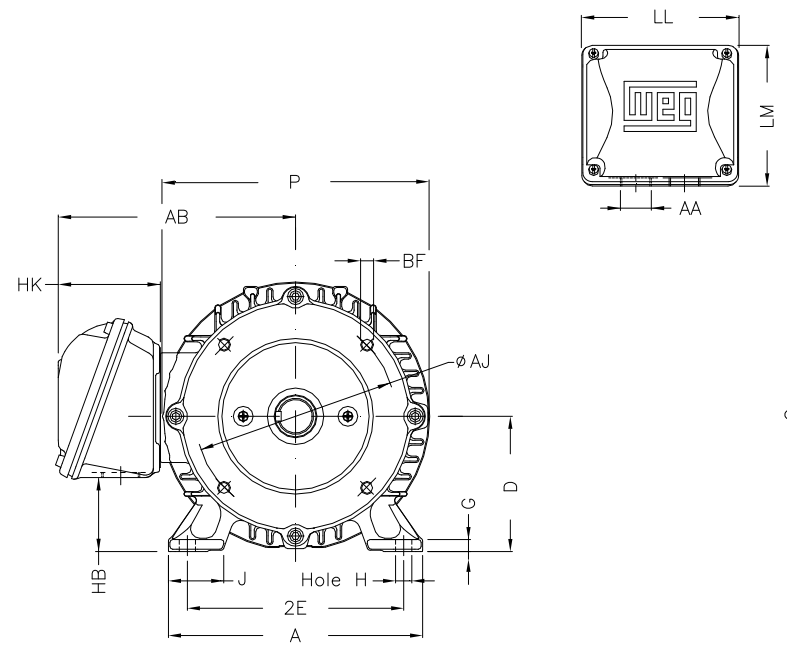

2E	J	A	P	AB
5.500	1.437	6.457	7.244	6.260
2F	B	BA	FBA	U
4.000/5.000	6.142	2.250	4.082	0.875
N-W	ES	S	R	depth
2.250	1.575	0.187	0.771	0.187
D	G	HB	O	T
3.500	0.354	1.787	7.122	0.007
HF	HH	HK	EV	H
3.500	4.750	2.638	0.571	0.340
C	FC	LL	LM	AA
13.346	15.202	4.528	4.094	NPT 3/4"
d1	Flange	AJ	AK	BD
A 3.15	FC-149	5.875	4.500	6.500
BF	BB	BC	AH	
UNC 3/8"x16	0.157	0.125	2.125	

Notes: Downloaded from <http://dealerselectric.com>
Generated for Model #00158ET3E145TC-W22

Performed by:

Checked:

Customer:

W22 NEMA Premium - Ball Bearings

Three-phase induction motor
Frame 143/5T - IP55

12-SEP-2016

