

1 2 3 4 5 6 7 8

A

B

C

D

E

F

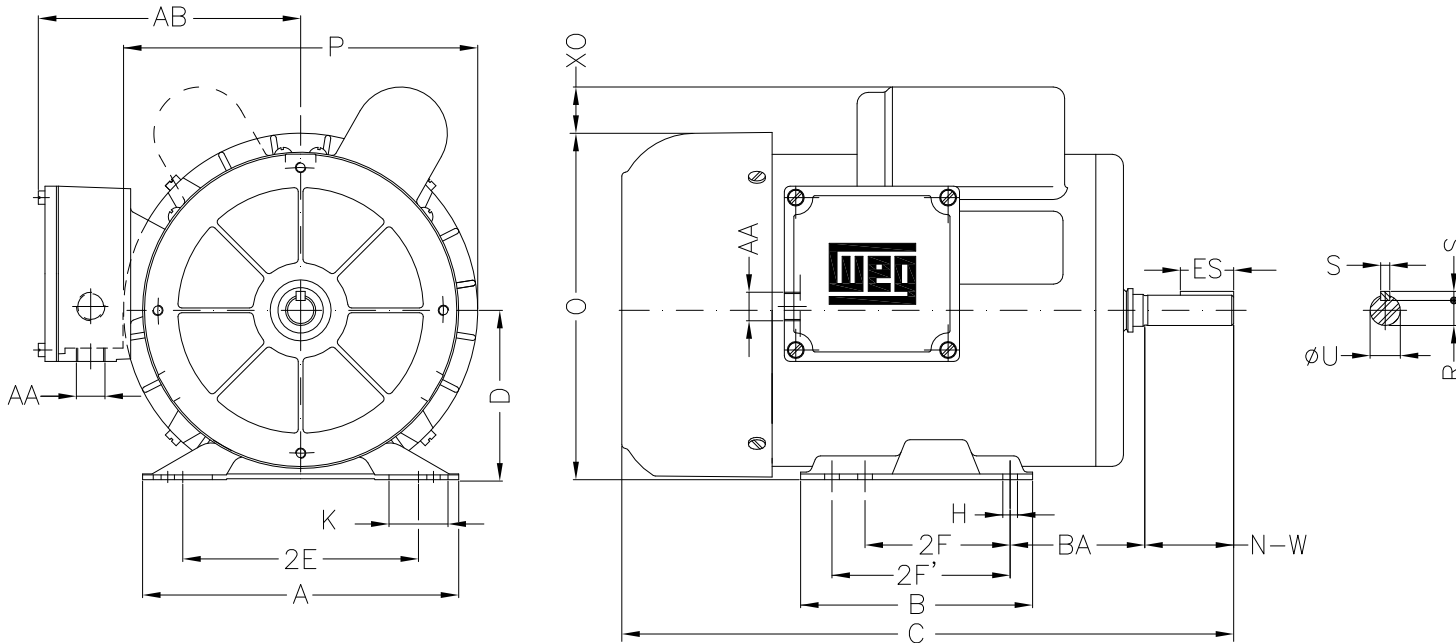

Notes: Downloaded from <http://dealerselectric.com>
Generated for Model #00158ES1B145T

Performed by:

Checked:

Customer:

Single-Phase : NEMA 56 TEFC

Single-phase induction motor
Frame G143/5T - IP55

12-SEP-2016



2E 5.500	H 0.342	A 6.535	2F 4.000/5.000	B 6.496
G 3.04	BA 2.250	J 1.220	K 5.000	P 7.323
ES 1.417	S 0.187	depth 0.187	N-W 2.250	U 0.8750
R 0.766	AB 5.433	d1 A 3,15	D 3.500	O 7.165
T 1.063	C 14.882	AA NPT 3/4"		