

1 2 3 4 5 6 7 8

A

B

C

D

E

F

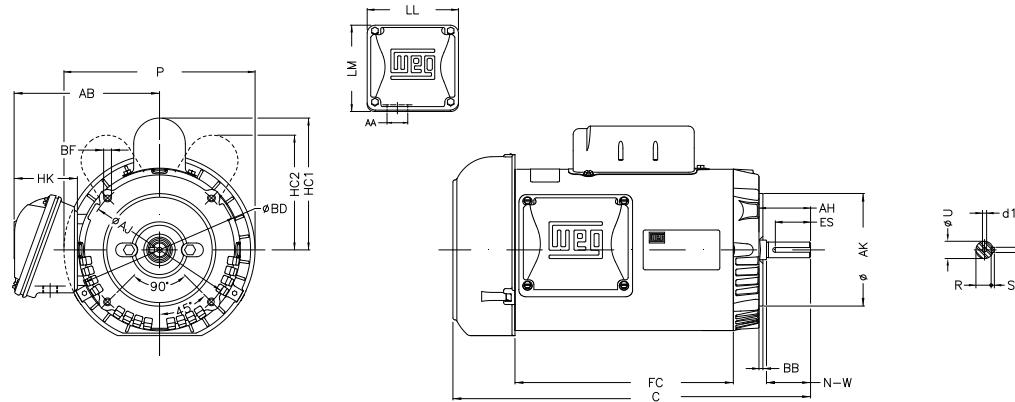

Notes: Downloaded from <http://dealerselectric.com>
Generated for Model #00156ES1B56CFL-S

Performed by:

Checked:

Customer:

Single Phase: W01 (Rolled Steel) - TEFC - Standard Efficiency

Single-phase induction motor
Frame 56 - IP55

12-SEP-2016



P	AB	HK	FC	C
7.638	5.882	2.638	8.268	13.902
N-W	ES	d1	S	U
1.874	1.417	A 3.15	0.187	0.625
AA	depth	R	LL	LM
0.881"	0.187	0.517	4.543	4.106
CH	HC2	Flange	AJ	AK
1.377	4.650	FC-149	5.874	4.500
BD	BF	BB	AH	
6.450	UNC 3/8"x16-2B	0.157	2.062	